

CODE OF SAFETY FOR SMALL COMMERCIAL VESSELS

OPERATING IN THE CARIBBEAN

SCV CODE 2017

Prepared

for

Caribbean Countries

With the support of the

International Maritime Organization

July 2017

PREAMBLE

The aim of this Code is to prescribe standards of construction, and emergency equipment for small commercial vessels operating in the Caribbean Region. The regulations are based on the United States Coast Guard Code of Federal Regulations 46 Sub-Chapter T (certification of small passenger vessels), which are regarded as equivalent to IMO Convention requirements for such vessels, Sub-Chapter C (Uninspected vessels) and The United Kingdom Code of Practice for the Safety of Small Workboats and Pilot Boats.

It should be noted that requirements for small commercial vessels of 24 metres and over in length, on international voyages, or those under 24 metres in length which carry more than 150 passengers or provide overnight accommodation for more than 50 passengers, are given in the Code of Safety for Caribbean Cargo Ships and the International Convention on the Safety of Life at Sea, 1974, as amended, (SOLAS) for cargo and passenger ships respectively. Nevertheless, small commercial vessels of 24 metres and over in length engaged on voyages in national waters only, could be allowed to operate under the provisions of this Code by the Administration.

Administrations are also encouraged to use this Code as a basis for any bilateral or multilateral agreements with respect to vessels on International Voyages.

Administrations that are party to SOLAS, who notify the International Maritime Organization (IMO) that the Code has been determined to be equivalent to the provisions of SOLAS under regulation I/5, for passenger vessels of less than 24 metres in length on international voyages, can issue such vessels with a SOLAS Passenger Ship Safety Certificate together with a copy of the notification of equivalency to IMO and where appropriate an exemption certificate.

Model Training Courses for Boatmasters and Boat Engineers are available from the Office of the Regional Maritime Adviser, Caribbean. These courses provide a blueprint for the training of Boatmasters and Boat Engineers and seek to ensure that persons who operate small commercial vessels are competent to carry out their duties efficiently. Contact information is as follows:

Office of the Regional Maritime Adviser

Telephone: 1-868-224-5490

2nd Floor, Clarence House

127 – 129 Duke Street

Port of Spain

Trinidad. W.I.

Email: cyoung@imo.org

regional.maritime.adviser@gmail.com

This publication contains revisions up to March 2017.

TABLE OF CONTENTS

CHAPTER I	1
GENERAL PROVISIONS	1
Part A - Application and Interpretation	1
1 Application.....	1
2 Definitions	3
3 Equivalence and exemptions	8
4 Approved equipment and material	9
5 Marking of vessels	9
6 Review.....	9
Part B – Inspections	9
7 General.....	9
8 Notice of inspection deficiencies and requirements	10
9 Unsafe practices.....	10
10 Hull and tailshaft examinations.....	10
11 Repairs, alterations and modifications.....	10
12 Additional tests and inspections	11
13 Maintenance of conditions after inspection.....	11
Part C – Passenger and Seafarer Capacity.....	11
14 Total number of persons permitted	11
Part D - Certification	12
15 Application for a small commercial vessel (SCV) safety certificate.....	12
16 Small commercial vessel (SCV) safety certificate	12
17 Description of certificate	13
18 Posting of certificates, permits and stability letters.....	13
19 Special permits.....	13
Part E – Passenger Ships on International Voyages	14
20 Certification	14
21 Safety management system.....	14
22 Ship security system	15
23 Additional requirements	15
Part F – Specific Ship Functions.....	16
24 General.....	16
25 Tugs.....	16
26 Mooring / Line handling boats.....	16
27 Personnel transfer vessels	16
28 Tankers.....	16
29 Rescue vessels	17
30 Supply Vessels	17
31 Vessels fitted with lifting appliances.....	17
32 Non self-propelled barges and pontoons	17
33 Submarines	18
34 Autonomous and unmanned vessels.....	18
CHAPTER II.....	19
CONSTRUCTION.....	19
Part A - General Provisions.....	19
1 General provisions.....	19
2 Plans and information to be submitted.....	19
3 Hull structure.....	19

Code of Safety for Small Commercial Vessels
Table of Contents

4	Means of escape	21
5	Rails and guards	22
Part B - Watertight and Weathertight Openings		22
6	Hatchways	22
7	Hatches which are open at sea	23
8	Doorways located above the weather deck.....	23
9	Companion hatch openings	23
10	Skylights	24
11	Portlights and windows	24
12	Ventilators.....	25
Part C - Antifouling		25
CHAPTER III		26
FREEBOARD, STABILITY AND WATERTIGHT INTEGRITY.....		26
Part A - Freeboard		26
1	Minimum freeboard.....	26
2	Loading marks.....	26
3	Loading of a vessel.....	26
Part B - Stability		26
4	Stability information for operating personnel.....	26
5	Stability information.....	27
6	Intact stability requirements in general	27
7	Intact stability requirements for a sailing vessel.....	28
8	Simplified stability proof test procedure and assumptions.....	29
9	Installation of ballast.....	32
10	Open boats	32
11	Foam flotation material.....	32
Part C - Watertight Integrity		33
12	Drainage of weather decks	33
13	Air pipes	34
14	Sea inlets and discharges.....	34
15	Materials for valves and associated piping.....	35
Part D - Subdivision.....		35
16	Collision bulkheads	35
17	Construction and location of collision bulkheads.....	35
18	Watertight subdivision bulkheads	36
19	Subdivision of cargo vessels.....	36
20	Subdivision of passenger vessels	37
21	Location of watertight bulkheads for subdivision	37
CHAPTER IV.....		41
MACHINERY.....		41
Part A - General Provisions.....		41
1	General requirements	41
2	Gasoline engines for propulsion.....	43
3	Outboard engines	44
4	Ventilation of spaces relating to gasoline.....	45
5	Ventilation of spaces relating to diesel.....	47
6	Exhausts	48
7	Engine starting	48
8	Portable plant	48

Code of Safety for Small Commercial Vessels
Table of Contents

9	Propulsion engine control systems	49
Part B - Steering and Propeller Systems		49
10	Main steering gear	49
11	Auxiliary means of steering	50
12	Propeller systems	51
Part C - Bilge Systems		51
13	General provisions for bilge systems	51
14	Bilge piping system	51
15	Bilge pumps	52
16	Bilge high level alarms	54
Part D - Electrical Arrangements		54
17	General provisions	54
18	Power sources	55
19	Electrical systems	57
20	Cables and wiring	57
21	Batteries	58
22	Battery installation	58
23	General grounding requirements	58
24	Lighting	59
25	Hazardous Spaces	59
CHAPTER V		60
FIRE PROTECTION		60
Part A - General Provisions		60
1	Fire protection provisions	60
2	Machinery space - construction	60
3	Insulation	61
4	Cooking appliances	61
5	Fire safety	62
Part B - Fire Extinguishing and Detecting Equipment		62
6	Equipment installed but not required	62
7	Fire pumps	63
8	Fire main and hydrants	63
9	Fire hoses and nozzles	63
10	Requirement for fixed fire extinguishing and detecting systems	64
11	Number, type and location of portable fire extinguishers	65
12	Fire axe	66
13	Fire bucket	66
14	Servicing of fixed and portable fire extinguishers	66
15	Fire blanket	66
CHAPTER VI		67
LIFESAVING EQUIPMENT		67
1	General provisions	67
2	Number and type of survival craft	67
3	EPIRB, SART and radar reflector	67
4	Distress signals	68
5	Lifebuoys	68
6	Lifejackets	69
7	Stowage of survival craft	70
8	Special provisions for buoyant apparatus	71

Code of Safety for Small Commercial Vessels
Table of Contents

9	Servicing and repair of life saving appliances	72
10	Survival craft equipment	73
11	Retro-reflective material	73
12	Rescue and retrieval of persons from the water	73
CHAPTER VII		74
MISCELLANEOUS SYSTEMS AND EQUIPMENT		74
1	General provisions.....	74
2	Navigation lights, shapes and sound signals.....	74
3	Charts and nautical publications.....	74
4	Navigation equipment	74
5	Radio and signalling equipment.....	75
6	Public address systems	76
7	Mooring and ground tackle	76
CHAPTER VIII.....		78
OPERATIONAL REQUIREMENTS		78
Part A - Operational Requirements.....		78
1	General provisions	78
2	Marine casualties	78
3	Logbook.....	79
4	Miscellaneous operating requirements	80
5	Pollution prevention equipment and procedures	81
6	Packaged dangerous goods	82
Part B - Preparations for Emergencies		85
7	Record of passengers	85
8	Passenger safety	85
9	Emergency instructions	87
10	Recommended emergency instructions format.....	87
11	Emergency station bill.....	88
12	Abandon ship and man overboard drills and training	89
13	Firefighting drills and training.....	90
14	Emergency situations.....	90
15	Markings required	90
16	Operational readiness, maintenance and inspection of lifesaving equipment.....	91
17	Instruction manuals, documentation, signs/notices and language used	91
CHAPTER IX.....		92
ACCOMODATION, WELFARE, WORKING AND LIVING CONDITIONS		92
Part A - Accommodation		92
1	General.....	92
2	Seafarer spaces	92
3	Water services.....	93
4	Galley	93
5	Toilet facilities	93
6	Stowage facilities for personal effects	93
7	Cooking and heating	93
8	Noise and vibration.....	94
9	First aid kit.....	94
10	Passenger accommodation.....	94
11	Passenger capacity	95

Code of Safety for Small Commercial Vessels
Table of Contents

12	Surface of working decks.....	96
13	Protection from mosquitoes	96
Part B - Hours of Rest.....		97
14	General.....	97
Part C - Manning.....		97
15	General.....	97
Part D – Maritime Labour Convention 2006 Equivalent Standards as Approved by the Administration		98
16	Application.....	98
17	Minimum age	98
18	Medical certification	99
19	Qualifications of seafarers.....	99
20	Seafarers’ employment agreements (SEA).....	99
21	Use of any licensed or certified or regulated private recruitment and placement service.....	99
22	Hours of work or rest.....	100
23	Manning levels for the vessel.....	100
24	Accommodation and recreational facilities.....	100
25	Food and catering	100
26	Health and safety, on-board medical care and accident prevention.....	101
27	On board complaint	101
28	Payment of wages	101
29	Social security.....	101
30	Financial security.....	101
31	Access to shore-based welfare facilities	102
32	Equivalent standard (MLC 2006) report.....	102
CHAPTER X		103
LICENCING OF BOATMASTERS AND ENGINEERS.....		103
Part A - Licences		103
1	Master	103
2	Engineers.....	103
3	Other seafarers.....	104
4	Licence issue, standards and conditions	104
5	Grades and area restrictions of boatmaster licences.....	104
6	Requirements for obtaining a boatmaster licence	105
7	Practical instruction.....	106
8	Examination for boatmaster licences	106
9	Grade and area restrictions of boat engineer licences	107
10	Requirements for obtaining a boat engineer licence	108
11	Approved course	108
12	Examination for boat engineer licences.....	108
13	Period of validity and renewal of licence	108
14	Medical fitness certificate.....	109
15	Record and surrender of licences	109
Annex 1		110
FORM OF SCV SAFETY CERTIFICATE.....		110
Annex 2		112
SIMPLIFIED STABILITY TEST PROCEDURE.....		112
TWENTY-FIVE PERCENT TEST.....		118

Code of Safety for Small Commercial Vessels
Table of Contents

STABILITY TEST PROCEDURE FOR VESSELS CARRYING PASSENGERS AND CARGO	119
Annex 2(A)	120
STABILITY INFORMATION	120
Annex 3	121
SMALL COMMERCIAL VESSEL SIMPLIFIED SUBDIVISION CALCULATION	121
Annex 4	126
FIRE TEST FOR FRP.....	126
Annex 5	127
IGNITABILITY TEST FOR COMBUSTIBLE INSULATIONS.....	127
Annex 6	129
RECOMMENDED EMERGENCY BROADCAST INSTRUCTIONS	129
Annex 7	130
ANCHORS AND CABLES.....	130
Annex 8	131
FIRST AID KITS.....	131
Annex 9	135
ESTIMATING GUIDELINES FOR HOLDING TANK CAPACITY	135
Annex 10	136
FORM OF BOATMASTER AND BOAT ENGINEER LICENCE	136
Annex 11	137
SYLLABUS FOR BOATMASTER AND BOAT ENGINEER LICENCES.....	137
Annex 12	147
PREVENTION OF POLLUTION BY GARBAGE FROM SHIPS	147
SAMPLE GARBAGE MANAGEMENT PLAN	149
PROCEDURES FOR COLLECTING GARBAGE	150
FORM OF GARBAGE RECORD BOOK.....	152
RECORD OF GARBAGE DISCHARGES	155
SAMPLE PLACARD.....	156
Annex 13	157
DETERMINATION OF LENGTH	157
Annex 14	158
ACCOMMODATION AND RECREATIONAL FACILITIES EQUIVALENT STANDARDS	158
1 Equivalent arrangements.....	158
2 Access/Escape arrangements.....	158
3 Headroom.....	158
4 Ventilation.....	158
5 Lighting.....	159
6 Water services and provision.....	159
7 Galley facilities and provision of food.....	159

Code of Safety for Small Commercial Vessels
Table of Contents

8	Hand Holds and Grab Rails	160
9	Sleeping accommodation.....	160
10	Sanitary facilities.....	161
11	Mess rooms.....	161
12	Recreational facilities.....	161
13	Stowage facilities for personal effects	162
14	Machinery space boundaries	162
15	Securing of heavy equipment	162
16	Master’s inspections	162
Annex 15 A		163
	Inspection Report for SCV Code Vessels keel laid before 1 July 2018	163
Annex 15 B		167
	Inspection Report for SCV Code Vessels keel laid on or after 1 July 2018	167
Annex 16		172
	Model of on-board complaint-handling procedures.....	172

CHAPTER I GENERAL PROVISIONS

PART A - APPLICATION AND INTERPRETATION

1 Application

1.1 The Code applies to vessels operating commercially, trading in the Caribbean Trading Area, which are 5 metres or more in length overall and less than 24 metres in length (L) and which, if carrying more than 12 passengers, operate within 20 miles of the nearest harbour or safe refuge, carry not more than 150 passengers and where overnight accommodation is provided, not more than 50 passengers overnight.

1.2 The Code shall not apply to:

- .1** fishing or pleasure vessels;
- .2** a vessel holding a valid International Passenger Ship Safety Certificate issued under the provisions of the International Convention on the Safety of Life at Sea, 1974, as amended (SOLAS) or Caribbean Cargo Ship Safety Certificate as appropriate;
- .3** a boat forming part of a vessels lifesaving equipment that is used to carry passengers only in emergencies or during emergency exercises;
- .4** a vessel of a foreign country, who's government has inspection laws approximating those of this Code or through bilateral or multilateral agreement, which has on board a current valid safety certificate, certificate of inspection, or other certificates permitting the carrying of passengers, or cargo in the appropriate sea areas, issued by its Government, unless there are clear grounds for believing that the condition of the vessel or of its equipment does not correspond substantially with the particulars of any of the certificates or is such that the vessel is not fit to proceed to sea without presenting an unreasonable threat to the safety of the vessel or its seafarers and passengers or the environment;
- .5** small commercial vessels which carry 12 or less passengers and hold a valid certificate issued under the provisions of a Code specially designed for such vessels. However, a Certificate of Compliance with the provisions of the SCV Code should be attached to the Certificate required by the Code to which such vessels were surveyed;
- .6** a vessel constructed or adapted for the carriage in bulk of liquid cargoes of a flammable or toxic nature (tanker).

1.3 Unless otherwise specified the Code applies to both new and existing vessels. Those items specified for new vessels may, where appropriate, be applied to existing vessels.

1.4 A phase in period is allowed for certain amendments in the Code:

.1 the following items which need not be applied until the next Certificate of Inspection renewal is due and the first SCV Safety Certificate is issued after 1 July 2014:

I/3.3	Recording of exemptions and equivalences on SCV Safety Certificate.
I/5	Marking of Vessels.
I/17	Navigational and communication equipment added to certificate content.
I/20.1	Limits passenger vessels under the Code to no more than 20 miles from a safe refuge.
II/4.5	Marking of escapes.
III/5.2	Five yearly lightship verification for passenger vessels
IV/1.7	Shutoff valve access from outside machinery spaces.
IV/1.11	Hoses must be double clamped.
IV/3.2.3	Explosion proof fittings in vicinity of gasoline.
IV/3.3	No fixed gasoline tanks in certain circumstances.
IV/6.2	Exhaust insulation.
IV/16.3	Automatic bilge pumps not allowed in spaces which may contain pollutants.
V/4.1.1	Modified cooking area fire protection requirements.
V/4.4	Specific gas shut off requirements added.
VI/3.1	Paragraph to apply to all vessels not only passenger vessels
VI/3.2	Updated to useful equipment for area and cover all vessels in exposed waters.
VI/4.1	Modified smoke floats to 2 similar to LSA Code.
VI/5.1	All vessels to have ring lifebuoys.
VI/5.4	Specification similar to SOLAS.
VI/6.2	Specified 2.5% infant lifejackets.
VI/6.3	Lights and whistles for all lifejackets.
VI/12.1	Retrieval system to bring person on board horizontally is specified.
VII/4.1.2	Compass for all propelled vessels.
VII/4.1.4	Allow hand-bearing compasses for protected waters.
VII/4.4	Add weather retrieval systems.
VII/5	Update for DSC and Sat-C requirements and independent batteries.
VIII/3	Logbook requirement for all vessels in exposed waters.
VIII/6	Packaged dangerous goods requirements added.
IX/5.2	Modified quantities of water.
IX/7.5	Added to clarify gas storage requirements.
IX/12	Noise and vibration now mentioned.
Annex 1	Updated format for certificate now called SCV Safety Certificate.

.2 stability calculations in Chapter **III** and **Annexes 2** and **3** which were based on LWL rather than L shall remain valid until a new stability calculation is deemed necessary.

.3 in Chapter **VII/4.3.1**, the requirement for vessels operating in coastal waters to be equipped with an electronic positioning device shall apply from 1 July 2018.

.4 in **Annex 1 Form of SCV Safety Certificate** to be implemented no later than the first

renewal after 1 July 2018.

1.5 In Chapter **III** and **Annexes 2** and **3**, the passenger weight of 82.5 kg applies to:

- .1** new vessels;
- .2** vessels that have had a major conversion on or after 1 July 2015; or
- .3** vessels where stability reassessment is considered necessary by the Administration.

1.6 Existing vessels shall comply with these standards for passenger weight requirements, Chapter **III/8.7.2** by 1 July 2019. The reassessment of stability for existing vessels may be done by a pro rata reduction in passenger capacity according to the difference between the current passenger weights specified in Chapter **III/8.7** SCV Code 2010 and Chapter **III/8.7.2 of this Code** without further testing.

2 Definitions

For the purpose of the Code, unless expressly provided otherwise:

- .1** *Accommodation spaces* are those spaces used for public spaces, corridors, lavatories, cabins, offices, hospitals, cinemas, game and hobby rooms, barber shops, pantries containing no cooking appliances and similar spaces.
- .2** *Administration* means the Maritime Administration of a Country.
- .3** *Beam or B* means the maximum width of a vessel measured:
 - .1** On wooden vessels from the outside of planking on one side to the outside of planking on the other; and
 - .2** On all other vessels from the outside of a frame on one side to the outside of a frame on the other.
- .4** *Bulbous bow* means a design of bow in which the forward underwater frames ahead of the forward perpendicular are swelled out at the forefoot into a bulbous formation.
- .5** *Bulkhead deck* means the uppermost deck to which watertight bulkheads and the watertight shell extends.
- .6** *Caribbean Trading Area* means an area bounded by a line from a point on the east coast of the United States of America in latitude 35° 00' north, to a point 5° 00' south, 33° 00' west; thence to a point 10° 00' south, 33° 00' west; thence to a point on the coast of Brazil in latitude 10° 00' south; thence northward along the coast of Continental America to a point in latitude 35° 00' north, on the east coast of the United States of America.

- .7** *Cargo space* means a:
- .1** Cargo hold;
 - .2** Refrigerated cargo space; or
 - .3** Trunk leading to or from a space listed above.
- .8** *Coastal waters* mean an area designated as such by an Administration in respect of its territorial seas and contiguous zone but which does not in any case extend to more than 20 nautical miles from a harbour or safe refuge. Where an Administration has not otherwise designated an area, it means an area not more than 20 nautical miles from a harbour or safe refuge.
- .9** *Cockpit vessel* means a vessel with an exposed recess in the weather deck extending not more than one-half of the length of the vessel measured over the weather deck.
- .10** *Commercial vessel* means a vessel in commercial use and means carrying cargo or passengers for reward on any voyage, or excursion. It does not include a fishing vessel.
- .11** *Draft* means the vertical distance from the moulded baseline of a vessel at mid length to the waterline.
- .12** *Enclosed space* means a space which has any of the following characteristics:
- .1** limited opening for entry and exit;
 - .2** inadequate ventilation; and
 - .3** is not designed for continuous worker occupancy.
- .13** *Existing vessel* means a vessel that is not a new vessel or a vessel for which initial construction has begun before 1 July 2015.
- .14** *Exposed waters* mean any waters that are more than 20 nautical miles from a harbour or safe refuge, or those other waters which are so designated by the Administration.
- .15** *Ferry* means a vessel that:
- .1** operates only in protected waters;
 - .2** has provisions only for deck passengers or vehicles, or both; and
 - .3** operates on a short run on a scheduled service between two or more places.
- .16** *Fishing vessel* means a vessel used or intended to be used for fishing for profit and does not include vessels used for the carriage of passengers used for sport fishing.

- .17** *Flash point* means the temperature in degrees Celsius (closed cup test) at which a product will give off enough flammable vapour to be ignited, as determined by an approved flashpoint apparatus.
- .18** *Float-free launching or arrangement* means that method of launching a survival craft whereby the survival craft is automatically released and break free from a sinking vessel in such a manner as to be ready for use by survivors.
- .19** *Flush deck vessel* means a vessel with a continuous weather deck located at the uppermost sheer line of the hull.
- .20** *Fibre-reinforced plastic (FRP)* is a composite material made of a polymer matrix reinforced with fibres. The fibres are usually glass (GRP), carbon, basalt or aramid, although other fibres such as paper or wood or asbestos have been sometimes used. The polymer is usually an epoxy, vinylester or polyester thermosetting plastic, and phenol formaldehyde resins are still in use.
- .21** *Harbour or Safe Refuge* means a port, inlet or other body of water normally sheltered from heavy seas by land presenting no special hazards and into which a vessel can safely navigate and where the persons on board can disembark into safety. The suitability of a location as a safe refuge is as determined by the Administration.
- .22** *Galley* means a space containing appliances with cooking surfaces that may exceed 120° C.
- .23** *Inflatable survival craft or Inflatable lifejacket* means one which depends upon non-rigid, gas-filled chambers for buoyancy and which are normally kept deflated until ready for use.
- .24** *IMDG Code* means the International Maritime Dangerous Goods Code published by the International Maritime Organization.
- .25** *International voyage* means a voyage between one country and a port outside that country.
- .26** *Launching appliance* means a device for transferring a survival craft, rescue boat or boat for the recovery of a man overboard from its stowed position safely to the water. For a launching appliance using a davit, the term includes davit, winch and falls.
- .27** *LBP* means the length on the summer load waterline from the fore side of the stem to the after side of the stern post or, in a vessel without a stern post, to the centre of the rudder stock.
- .28** *Length (L)* means the greater of 96% of the total length on a waterline at 85% of least moulded depth (measured from the top of keel) or the length from the fore side of the stem to the axis of the rudder stock on that waterline, if that is greater.
- .29** *Length overall (LOA)* means the distance measured in metres in a straight line on a line

parallel to the design waterline between the foreside of the foremost fixed permanent structure and the after side of the aftermost permanent structure.

For the purpose of this definition (see also **Annex 13**):

- .1** the foremost fixed permanent structure is taken to include the watertight hull structure, the forecastle, stem and forward bulwark, if fitted, but not to include bowsprits and safety rail;
 - .2** the aftermost permanent structure is taken to include the watertight hull structure, transom, poop, and bulwark, but does not include safety rails, bumkins, propulsion machinery, rudders and steering gear, and divers' ladders and platforms;
 - .3** inflatable, rigid inflatable boats, or boats fitted with a buoyant collar, length should be taken from the foremost part of tube or collar, to the aft most part of the tube or collar.
- .30** *LSA Code* means the International Life-Saving Appliance (LSA) Code adopted by the Maritime Safety Committee of the International Maritime Organization at its sixty-sixth session by Resolution MSC.48(66) as amended.
- .31** *Machinery space* is to be taken as extending from keel to the free board deck and between the extreme main transverse water-tight bulk heads, bounded by the spaces containing the main and auxiliary propulsion machinery, boilers, serving the needs of propulsion. In case of unusual arrangements, the Administration may define the limits of the Machinery Spaces.
- .32** *Major conversion* means repairs, alterations or modifications that:
- .1** substantially alter the dimensions of a vessel;
 - .2** substantially increase a vessel's service life; or
 - .3** alter the functional aspects of a vessel.
- .33** *Master* means the individual person having command of a commercial vessel.
- .34** *Means of escape* means a continuous and unobstructed route from any point in a vessel to an embarkation station. A means of escape can be both vertical and horizontal, and may include doorways, passageways, stair towers and public spaces. Cargo spaces, machinery spaces, rest rooms, hazardous areas, escalators and elevators shall not form any part of a means of escape.
- .35** *Near-Coastal Voyage* means voyages in the vicinity of a Party to the STCW Convention as defined by that Party.
- .36** *New vessel* means a vessel for which the initial construction began on or after 1 July 2015

or a vessel which has undergone a major conversion on or after 1 July 2015, unless specified otherwise.

- .37** *Non-self-propelled vessel* means a vessel, which does not have a means of propulsion installed, such as propulsive machinery, masts, spars or sails.
- .38** *Open boat* means a vessel which is open to the elements and is not fitted with a complete watertight or weathertight deck or complete structure above the waterline.
- .39** *Operating station* means the principal steering station on the vessel from which the individual on duty normally navigates the vessel.
- .40** *Overnight accommodation or overnight accommodation space* means an accommodation space for use by passengers or by seafarers which has one or more berths, including beds or bunks, for passengers or seafarers to rest for extended periods. Overnight accommodations do not include spaces, which contain only seats, including reclining seats.
- .41** *Passenger* means any person carried in a vessel except a person employed or engaged in any capacity on board the vessel or a child under one year of age.
- .42** *Passenger vessel* means a vessel other than a pleasure vessel carrying more than 12 passengers.
- .43** *Piping system* includes piping, associated fittings and valves.
- .44** *Pleasure vessel* means:
- .1** any vessel which at the time it is being used is:
 - .1** in the case of a vessel wholly owned by an individual or individuals, only for the sport or pleasure of the owner or the immediate family or friends of the owner; or
 - .2** in the case of a vessel owned by a body corporate, one on which the persons are employees, officers or shareholders of the body corporate, or their immediate family or friends; and
 - .2** on a voyage or excursion which is one for which the owner does not receive money for or in connection with operating the vessel or carrying any person.
- .45** *Protected waters* means an area designated as such by an Administration for the operation of small vessels in respect of its territorial seas, which consists of sheltered waters presenting no special hazards. Where an Administration has not otherwise designated an area, it means an area which does not in any case extend to more than 3 nautical miles from a safe refuge.
- .46** *Seafarer* means any person who is employed or engaged or works in any capacity on board

a vessel to which this Code applies.

- .47** *Seafarer accommodation space* means an accommodation space designated for the use of seafarers which passengers are not allowed to occupy.
- .48** *Survival craft* means a craft capable of sustaining the lives of persons in distress from the time of abandoning the ship.
- .49** *To the satisfaction of the Administration* means in accordance with National Legislation. Where this is not sufficiently specific then reference should be made to relevant IMO (International Maritime Organization) publications and IACS (International Association of Classification Societies) guidance or industry best practice in the area concerned. See also paragraphs **I/3.1** and **I/4**.
- .50** *Vessel* includes any ship or boat or any other description of vessel capable of being navigated.
- .51** *Voyage* includes an excursion.
- .52** *Watertight* means designed and constructed to prevent the passage of water in any direction under the head of water likely to occur in the intact or damaged condition.
- .53** *Weather deck* means any deck exposed to the outside.
- .54** *Weathertight* means that in any sea conditions water will not penetrate into the vessel.
- .55** *Well deck vessel* means a vessel with a weather deck fitted with solid bulwarks that impede the drainage of water over the sides or a vessel with an exposed recess in the weather deck extending more than one-half of the length of the vessel measured over the weather deck.
- .56** *Workspace* means a space, not normally occupied by a passenger, in which a seafarer performs work and includes, but is not limited to, a galley, operating station or machinery space.

3 Equivalence and exemptions

3.1 Where the Code requires that a particular fitting, material, appliance or apparatus, or type thereof, piece of equipment or machinery shall be fitted or carried in a vessel, or that any particular provision shall be made, the Administration may permit any other fitting, material, appliance or apparatus or type thereof, piece of equipment or machinery to be fitted or carried or other provision to be made in that vessel where it is satisfied by trials or otherwise that the alternative is at least as effective as that required by the Code.

3.2 The Administration may exempt any vessel or description of vessels from all or any of the provisions of the Code, as shall be specified in the exemption, provided that the Administration is satisfied that compliance with such provision is either impracticable or unreasonable in the case of that vessel or description of vessels. The exemption may be issued on such terms, if any, as the

Administration may specify and subject to giving reasonable notice, the Administration may alter or cancel any such exemption.

3.3 Where an Administration has permitted an alternative in accordance with paragraph **I/3.1** it shall note the equivalence on the certificate issued to the vessel.

4 Approved equipment and material

Equipment and material that is required by the Code to be approved or of an approved type shall have been manufactured and approved in accordance with the design and testing requirements of the Administration. In determining design and testing requirements the Administration shall follow accepted international requirements and may delegate the testing and certification to an authorised Notified Body or Recognized Organization. See also paragraph **I/3.1**.

5 Marking of vessels

In order to identify the vessel at least the name of the vessel shall be clearly displayed to the satisfaction of the Administration. Where appropriate the vessel shall also display other markings in accordance with the Code, national and international requirements.

6 Review

6.1 The Code will be reviewed by a committee, nominated by the Senior Maritime Administrators in the Caribbean, at intervals not exceeding three years to take into account experience and new statutory requirements which apply to vessels of a similar size or type and may be considered reasonable to apply to vessels operating under the Code.

6.2 When new standards are developed and finalized by the International Maritime Organization (IMO), the International Organization for Standardization (ISO) or any other international body, which impact upon the requirements of the Code, amendment of the Code may be considered by the committee mentioned in **6.1** immediately and appropriate action taken.

PART B – INSPECTIONS

7 General

7.1 Inspections for certification are based on the information, specifications, drawings and calculations available to the Administration.

7.2 The initial or renewal inspection will cover the following items: hull, machinery, electrical equipment, lifesaving equipment, fire protection equipment, pressure vessels and boilers, steering systems, miscellaneous equipment and systems, sanitation and operational practices including the competence and composition of seafarers.

7.3 In general, the scope of an annual inspection is the same as for the inspection for issue of a Small Commercial Vessel (SCV) Safety Certificate but in less detail.

7.4 The inspection and survey of ships, so far as regards the enforcement of the provisions of this Code and the granting of exemptions there from, should be carried out by officers of the Administration. The Administration may, however, entrust the inspections and survey either to surveyors nominated for the purpose or to organizations recognised by it.

8 Notice of inspection deficiencies and requirements

During the inspection of a vessel, the inspector will record any deficiencies. On completion of the Inspection the inspector will provide the Master with a list of any deficiencies uncovered and if they cannot be rectified immediately where the inspector is satisfied that the vessel may continue in service for a short period without danger to life or the environment the time period for rectification shall be indicated and the Master notified of any further conditions and requirements for rectification.

9 Unsafe practices

During the course of any inspection due regard shall be given to confirming that all unsafe practices identified on board have been corrected. Examples of this may include such things as fire hazards by virtue of oily residues, unguarded machinery and incorrect use of any protective clothing or devices necessary for the safety of seafarers.

10 Hull and tailshaft examinations

10.1 A thorough examination of the hull, tailshaft, rudders and propellers shall be carried out at the initial and renewal surveys, at the third annual survey and at the discretion of the Administration.

10.2 A passenger vessel certified for operation in exposed waters¹ shall undergo a thorough examination of the hull at least annually.

10.3 The extent and method of tail shaft examination shall be at the discretion of the Administration taking into consideration manufacturer's guidance for such items as bearings and seals.

10.4 Hull and tailshaft examinations shall include all fittings, fixtures and penetrations of the hull and strengthening arrangements.

11 Repairs, alterations and modifications

11.1 Repairs or alterations to the hull, machinery or equipment, which affect the safety of the vessel shall not be made without the approval of the Administration, except in an emergency. Drawings or written specifications of proposed alterations should be submitted to the Administration for review and approval. The Administration may require that inspections and or testing be carried out before, during and after effecting the repairs, alterations or modifications to the vessel.

11.2 Safe working practices shall be observed in the planning and execution of any alterations,

¹Passenger vessels to which this Code applies must operate within 20 miles of the nearest harbour or safe refuge.

repairs or other operations involving riveting, welding, burning or other fire producing actions aboard a vessel particularly where these take place adjacent to fuel tanks or apparatus connected to the fuel tanks.

11.3 A major conversion and outfitting related thereto on existing vessels shall meet the requirements prescribed for a new vessel to such extent as the Administration deems reasonable and practicable. The owner shall inform the Administration of the proposed alterations and modifications before such alterations and modifications are carried out.

12 Additional tests and inspections

12.1 The Administration may make inspections or tests of the vessel in addition to those described within this chapter, as deemed necessary to determine that the vessel and its equipment are suitable for the service in which they are to be employed.

12.2 The Administration may withdraw or amend an SCV Safety Certificate if it is found that a vessel does not comply with the requirements of this Code.

13 Maintenance of conditions after inspection

13.1 The condition of the vessel and its equipment shall be maintained to conform with the provisions of the Code to ensure that the vessel in all respects will remain fit to proceed to sea without damage to the vessels or persons on board.

13.2 After any inspection of a vessel has been completed, no change shall be made in the structural arrangements, machinery or other items covered by the survey without the approval of the Administration.

13.3 Whenever an accident occurs to a vessel or a deficit is discovered which affects the safety of the vessel or the efficiency or completeness of its life saving appliances or other equipment, the master or owner of the vessel shall report it at the earliest opportunity to the Administration, who shall determine if an inspection is necessary.

PART C – PASSENGER AND SEAFARER CAPACITY

14 Total number of persons permitted

14.1 The total numbers of persons permitted to be carried on a vessel shall be determined by the Administration.

14.2 In determining the total number of persons permitted to be carried the Administration shall take into account the applicable stability restrictions and subdivision requirements in **Chapter III**, the vessel's operating area, general arrangement, means of escape, lifesaving equipment, minimum manning requirements and the maximum number of passengers permitted in accordance with **IX/11.2** and **IX/11.3**.

14.3 The total number of persons permitted to be carried should not exceed the total number of

persons calculated to be on board when the vessel successfully completed the stability requirements of regulation **III/8**.

PART D - CERTIFICATION

15 Application for a small commercial vessel (SCV) safety certificate

An SCV Safety Certificate may be obtained or renewed by making an application in writing to the Administration. The application for inspection of a vessel being newly constructed or converted shall be submitted prior to the start of the construction or conversion.

16 Small commercial vessel (SCV) safety certificate²

16.1 A vessel to which the Code applies shall not be operated without having on board a valid SCV Safety Certificate issued by the Administration following a satisfactory inspection. The form of the certificate is given in **Annex 1**. This certificate shall remain valid for a period not exceeding 1 year for vessels carrying more than 12 passengers on international voyages and not exceeding 5 years for all other vessels from the date of inspection subject to **16.2** provided that the vessel successfully completes an annual inspection or unless revoked by the Administration.

16.2 The inspection for the renewal of the certificate shall be conducted up to 3 months prior to the expiry of the SCV Safety Certificate. Where the renewal inspection is completed within the three months prior to the date of expiry of an SCV Safety Certificate or Certificate of Inspection, the new certificate may be issued for a period extending to 1 or 5 years from the expiry date of the previous certificate as appropriate.

16.3 In the case of a vessel which is issued with an SCV Safety Certificate which is valid for more than 1 year; the day and month of that expiry date of that certificate shall be defined as the vessel's anniversary date.

16.4 The annual inspection shall be conducted during the period of 6 months extending from three months before to three months after the anniversary date in each year until the renewal date of the certificate.

16.5 The annual inspection shall be sufficient to establish that the vessel continues to meet the requirements of the Code and on satisfactory inspection of the vessel the SCV Certificate shall be endorsed to show the completion of the annual inspection.

16.6 An SCV Safety Certificate which is not endorsed to show the completion of the required annual inspection is invalid and the vessel must be submitted for a renewal inspection and the issue of a new SCV Safety Certificate.

16.7 Every vessel to which an SCV Safety Certificate has been issued shall conform to these

²A Certificate of Inspection previously issued under the requirements of the Code will be accepted as valid until its expiry date.

regulations and any additional measures deemed appropriate by the Administration throughout the period of validity of the certificate.

17 Description of certificate

The SCV Safety Certificate issued to a vessel shall describe:

- the vessel;
- the date of inspection and expiry of the certificate;
- the issuing authority;
- the operating area specified under headings "*Protected waters*", "*Coastal waters*" or "*Exposed Waters*";
- the minimum manning requirements;
- the fire detection and extinguishing equipment required;
- the lifesaving appliances to be carried;
- the communication equipment to be carried;
- the navigational equipment to be carried;
- the maximum number of passengers and total persons that shall be carried;
- the number of passengers the vessel may carry in overnight accommodation spaces;
- the name of the owner and managing operator;
- any equivalencies or exemptions accepted or authorised by the Administration;
- any other such conditions of operation as may be determined by the Administration.

18 Posting of certificates, permits and stability letters

The SCV Safety Certificate and any stability letters shall be posted under glass or other suitable transparent material, such that all pages are visible, in a conspicuous place on the vessel where observation by passengers is likely. Where posting is impracticable, the certificates shall be kept on board in a weathertight container readily available for presentation to passengers and, officials of the flag State or port State when requested.

19 Special permits

19.1 Where a vessel does not hold a valid SCV Safety Certificate, the Administration may permit the vessel to proceed without passengers to another port for repairs, under such conditions as may be considered necessary. Application for such permission should be made in writing to the Administration.

19.2 The Administration, in exceptional circumstances, for the safety of life or protection of the marine environment may permit a vessel to engage in a voyage with a greater number of persons or on a more extended route, or both, than permitted by its SCV Safety Certificate where it is satisfied that the operation can be undertaken safely.

PART E – PASSENGER SHIPS ON INTERNATIONAL VOYAGES**20 Certification**

20.1 Administrations that are party to SOLAS, who notify IMO that the Code has been determined to be equivalent to the provisions of SOLAS under regulation I/5, for passenger vessels of less than 24 metres in length on international voyages, may issue such vessels with a SOLAS Passenger Ship Safety Certificate along with a copy of the notification of equivalency to IMO and where appropriate, an exemption certificate. Such vessels should meet SCV exposed water requirements and be limited to operate not more than 20 miles from a safe refuge.

20.2 Vessels issued with a SOLAS Passenger Ship Safety Certificate in accordance with regulation I/20.1 shall also comply with the requirements of regulations I/21 and I/22 for the issue of a Document of Compliance and Safety Management Certificate, and a Ship Security Certificate respectively and with regulation I/23.

21 Safety management system

Passenger Ships on international voyages and issued with a SOLAS Passenger Ship Safety Certificate shall in addition to the requirements of the SCV Code, comply with the requirements of the following:

21.1 The owner of a passenger vessel engaged on international voyages, or any other organization or person such as the manager or the bareboat charterer who has assumed responsibility for the operation of the ship from the owner, and the vessel shall comply with the requirements of:

- .1** Chapter IX of the International Convention for the Safety of Life at Sea (SOLAS) 1974 as amended; and
- .2** the International Safety Management Code for the Safe Operation of Ships and Pollution Prevention, adopted in London on 24 May 1994.

21.2 In complying with the requirements of I/21.1 due regard shall be taken of the type of vessel involved and the service which it is undertaking.

21.3 A Document of Compliance shall be issued to every company which complies with the requirements of the International Safety Management Code. This document shall be issued by the Administration, by an organization recognized by the Administration, or at the request of the Administration by another Contracting Government to SOLAS.

21.4 A copy of the Document of Compliance shall be kept onboard the ship in order that the master can produce it on request for verification.

21.5 A Certificate, called a Safety Management Certificate, shall be issued to every ship by the Administration or an organization recognized by the Administration. The Administration or organization recognized by it shall, before issuing the Safety Management Certificate, verify that the company and its shipboard management operate in accordance with the approved safety-management system.

21.6 The safety-management system shall be maintained in accordance with the provisions of the International Safety Management Code.

22 Ship security system

Passenger Ships on international voyages and issued with a SOLAS Passenger Ship Safety Certificate shall in addition to the requirements of the SCV Code, comply with the requirements of the following:

22.1 The owner of a passenger vessel engaged on international voyages, or any other organization or person such as the manager or the bareboat charterer who has assumed responsibility for the operation of the ship from the owner, and the vessel shall comply with the requirements of:

- .1** Chapter XI-2 of the International Convention for the Safety of Life at Sea (SOLAS) 1974 as amended; and
- .2** the International Ship and Port Facility Security Code for the Security of Ships and of Port Facilities, adopted in London on 12 December 2002.

22.2 A Certificate, called an International Ship Security Certificate, shall be issued to every ship by the Administration or an organization recognized by the Administration. The Administration or organization recognized by it shall, before issuing the Ship Security Certificate, verify that the ship's security system and any associated equipment fully complies with Chapter XI-2 and Part A of the International Ship and Port Facility Security Code, is in satisfactory condition and fit for the service for which the ship is intended.

22.3 The ship security system shall be maintained in accordance with the provisions of the International Ship and Port Facility Security Code.

22.4 Seafarers on board vessels which are required to have an International Ship Security Certificate shall also have undergone security related training as required by Section A-VI/6 of STCW Code, with security officers trained and certified as required by Section A-VI/5 of STCW Code.

23 Additional requirements

23.1 Passenger Ships on international voyages and issued with a SOLAS Passenger Ship Safety Certificate shall in addition to the requirements of the SCV Code, comply with the requirements of the following:

- .1** Regulation V/19.2.4 (automatic identification system (AIS)) of the International Convention for the Safety of Life at Sea (SOLAS) 1974 as amended; and
- .2** Regulations 3 (ship identification number) and 5 (continuous synopsis record) of Chapter XI-1 of SOLAS.

PART F – SPECIFIC SHIP FUNCTIONS**24 General**

24.1 This section highlights some of the main areas where special attention is needed with certain types of vessels which are not covered in detail in the code. These requirements shall be read in conjunction with the appropriate good practice guidance provided by the relevant Industry Bodies as well as Classification Societies and Recognised Organisations.

25 Tugs

25.1 Masters are to be provided with appropriate information concerning the towage capability and maximum bollard pull of the vessel and stability information shall take account of towing loads with particular attention to possible effects of events such as girting and the effects of perpendicular loads;

25.2 Arrangements for connecting the tow line(s) shall be such as to facilitate quick release in the event that the Safe Working Load of the towing arrangement is exceeded or a need for emergency release;

25.3 Suitable means of communication between wheelhouse and persons working in vicinity of the area connecting or releasing the tow shall be provided;

25.4 Appropriate risk assessments must be conducted prior to towing operations and must be kept up to date; and

25.5 Tow pins and preventers shall be provided, as necessary, on open aft decks.

26 Mooring / Line handling boats

26.1 Special attention must be paid to minimizing obstructions on the working deck in order to facilitate safe handling of the lines.

27 Personnel transfer vessels

27.1 Means of transfer of personnel at sea shall be such as to minimize the risk of harm to personnel involved in the operation with special attention paid to minimizing the hazards that can lead to crushing and falling overboard;

27.2 These vessels will require special guard rail arrangements which differ from **II/5** these arrangements are to be noted on the certificate; and

27.3 The transfer point shall be fully visible from the helm position.

28 Tankers

28.1 This Code does not apply to vessels constructed or adapted for the carriage in bulk of liquid cargoes of a flammable or toxic nature (tankers);

28.2 Other tankers carrying nonflammable or nontoxic cargoes shall have appropriate stability information inclusive of free surface effects available to the Master; and

28.3 Proper arrangements shall be made for the handling and stowage of cargo hoses.

29 Rescue vessels

29.1 These are vessels whose role is to provide rescue services in the event of maritime emergencies requiring the rescue of personnel;

29.2 The part of the vessel used for conducting rescue operations (rescue zone) shall be located clear of hazards presented by propulsion systems and overboard discharges;

29.3 The rescue zone shall be clearly visible from helm position;

29.4 The rescue zone shall be marked on the hull of the vessel so as to be clearly identifiable to persons in the water; and

29.4 Appropriate arrangements must be made to protect rescue personnel from any hazards associated with the rescue.

30 Supply Vessels

30.1 These vessels are designed to take supplies to offshore installations;

30.2 Attention shall be paid to the design of the cargo deck and related equipment to facilitate safe lifting operations at sea; and

30.3 Vessels shall comply with the requirements of chapter **VIII** with respect to carriage of dangerous goods with appropriate anti-pollution measures.

31 Vessels fitted with lifting appliances

31.1 These vessels shall have sufficient stability information provided with respect to lifting operations that may be undertaken and the limits related to lifting capacity; and

31.2 Vessels engaged in anchor handling activities require similar information and working deck spaces shall be laid out in such a manner as to facilitate safe working.

32 Non self-propelled barges and pontoons

32.1 Suitable arrangements shall be in place for bilge level monitoring and pumping;

32.2 Safe means of access and egress must be provided if personnel are required to be on board;

32.3 Appropriate guardrail arrangements to be provided if personnel are required to remain on board;

32.4 If accommodation is provided it shall be suitable for the intended area of service; and

32.5 Passengers are not to be carried on these vessels when under tow.

33 Submarines

33.1 These will have additional requirements in such areas as air supply. Emergency procedures are needed for both surface and submersed modes of operation; and

33.2 The operation of such vessels shall be subject to detailed risk assessments.

34 Autonomous and unmanned vessels

34.1 The control of these vessels rests with persons not located on board, with the potential for fully autonomous vessels to conduct voyages entirely with no human intervention, whilst unmanned vessels may be controlled, on their voyages, from a remote location;

34.2 These types of vessels will be subject to special consideration and will require exemptions from many provisions of the Code primarily because there are no seafarers on board to operate the vessel and its equipment. Appropriate equivalences shall be determined dependent upon the nature of the operations;

34.3 Operations involving these vessels shall be fully risk assessed with consideration being given to such aspects as interrelation with other vessels and possible safe human intervention requirements;

34.4 The operation of these vessels will require the issuance of Notices to Mariners and the necessary information shall be provided to the relevant authorities to enable the appropriate promulgation of such notices;

34.5 Whilst these vessels are not subject to manning requirements, those responsible for their operation should be appropriately qualified, trained and considered competent to control such vessels; and

34.6 Special consideration will be required where the operators are located outside of the territory in which the vessel is operating.

CHAPTER II CONSTRUCTION

PART A - GENERAL PROVISIONS

1 General provisions

1.1 The construction and arrangement of a vessel shall allow the safe operation of the vessel in accordance with the terms of its SCV Safety Certificate giving consideration to:

provisions for a seaworthy hull;
protection against fire;
means of escape from all spaces likely to be occupied by passengers or seafarers;
guards and rails in hazardous places;
ventilation of enclosed spaces; and
necessary facilities for the accommodation and use of passengers and seafarers.

1.2 Unless authorized by the Administration, a vessel certified for operation in exposed waters shall be fitted with a watertight weather deck over the length of the vessel and be of adequate structural strength to withstand the sea and weather conditions likely to be encountered in the area of operation. The vessel shall be so constructed as to meet the appropriate requirements of **Chapter III**.

2 Plans and information to be submitted

2.1 The owner of a vessel requesting initial inspection for certification shall, prior to the start of construction unless otherwise allowed by the Administration, submit for approval to the Administration, at least two copies of plans concerning the following areas: machinery installation including piping systems; electrical installation; arrangement in detail of lifesaving equipment; arrangement in detail of fire equipment, mast and rigging arrangements; navigation lights; steering and control equipment; and sanitation arrangements.

2.2 For a vessel of not more than 20 m in length overall, the owner may submit specifications, sketches, photographs, line drawings or written descriptions instead of any of the required drawings, provided the required information is adequately detailed and acceptable to the Administration.

2.3 The provisions of **II/2.1** and **II/2.2** apply equally to existing vessels.

2.4 All new vessels engaged on international voyages outside coastal waters shall carry on board copies of the plans detailed in **II/2.1** which shall be approved by the Administration.

3 Hull structure

3.1 Except as provided in **II/3.7** a vessel shall comply with the applicable design requirements of one of the Rules and Regulations of a member of the International Association of Classification Societies

(IACS)³ or such other rules and regulations as the Administration deems fit for a vessel's construction.

3.2 A vessel which is constructed in accordance with the rules of a Classification Society which is a member of IACS for a vessel of its size, material and method of construction will be accepted as having an adequate standard of construction and design in so far as the hull structure is concerned provided that the structure remains in good condition and wear, and corrosion and other effects have not reduced the structure below the allowances stated by that Classification Society.

3.3 A vessel that has not been constructed in accordance with the rules of an IACS Classification Society may be considered of adequate hull strength provided that the Administration is satisfied that:

- .1** in the case of a steel or aluminium vessel, the construction is in accordance with established steel or aluminium vessel construction standards including, in particular the prevention of electrolytic corrosion in aluminium vessels; and
- .2** the scantlings are adequate taking into account the intended draught of the vessel as opposed to the intended freeboard at load draught, the area of operation, the intended deck loads and any other factors affecting the overall strength in service.

In the case of an existing steel or aluminium vessel that has not been constructed in accordance with the rules of an IACS Classification Society the Administration may accept the vessel as having adequate construction and strength standards provided that it has a history of acceptable performance in service and the corrosion reduction in any part of the structure does not exceed 20% from the original scantlings.

3.4 A vessel that has not been constructed in accordance with the rules of an IACS Classification Society may be considered of adequate hull strength provided that the Administration is satisfied that in the case of a FRP vessel the construction is in accordance with good industry practice as regards FRP construction using resins and reinforcing material approved for boat construction and with scantlings that are adequate taking into account the intended use of the vessel, the draught as against the intended freeboard and the necessary reinforcing to withstand cargo and deck loads. In the case of an existing FRP vessel that has not been constructed in accordance with the rules of an IACS Classification Society the Administration may accept the vessel as having adequate construction and strength standards provided that it has an acceptable history in service and the FRP structure remains free of de-lamination,

³ Details of IACS members can be found at www.IACS.org.uk

Applicable standards for the material and construction of the vessel include the following:

- .1** Wooden hull vessels - Rules and Regulations for the Classification of Yachts and Small Craft, Lloyd's Register of Shipping (LR).
- .2** Steel hull vessels - and Regulations for the Classification of Special Service craft, LR; or Rules for Building and Classing Steel Vessels under 90m in length, American Bureau of shipping (ABS).
- .3** Fibre reinforced plastic vessels - Rules and Regulations for the Classification of Special Service Craft, LR; or Rules for Building and Classing Reinforced Plastic Vessels, ABS.
- .4** Aluminium hull vessels- Rules and Regulations for the Classification of Special Service Craft, LR. Rules for Building and Classing Aluminium vessels ABS.

significant osmosis, cracks or other damage.

3.5 Inflatable vessels and vessels with partially inflated hull structures (RHIBs and similar) which have not been constructed in accordance with the rules for such vessels set out by an IACS Classification Society shall meet the standards in the LSA Code for inflatable rescue boats. Administrations may accept existing inflatable vessels as having adequate construction standards if they have a history of adequate performance in service and show no signs of serious wear, leakage, or materials deterioration.

3.6 Vessels built to other standards shall be considered specifically by the Administration and appropriate records maintained.

3.7 An existing vessel shall be considered to be of acceptable construction where it is:

- .1** built to one of the standards described in **II/3.1**; or
- .2** of a design with a record of at least five years history of safe operation in an area where the sea and weather conditions and manner of use are no less severe than those likely to be encountered in the area of operation.

3.8 The design, materials, and construction of masts, posts, yards, booms, bowsprits, and standing rigging on a sailing vessel should be suitable for the intended service. The hull structure should be adequately reinforced to ensure sufficient strength and resistance to distortion.

4 Means of escape

4.1 Each space of more than 3.7 m in length accessible to passengers or used by seafarers on a regular basis shall have at least two means of escape, one of which shall not be a watertight door.

4.2 The two required means of escape shall be widely separated and, where possible, at opposite ends or sides of the space to minimise the possibility of one incident blocking both escapes. Means of escape may include normal exits and emergency exits, passageways, stairways, ladders, deck scuttles, and windows. The number and dimensions of the means of escape from each space shall be sufficient for rapid evacuation in an emergency of the maximum number of persons likely to occupy the space under any operational conditions. The size of the escapes shall be to the satisfaction of the Administration.

4.3 In a passenger vessel, the smallest width of any doors and passageways used as means of escape from a space shall not be less than 810 mm. In a vessel which is not a passenger vessel the minimum width in any escape route shall not be less than 710 mm.

4.4 When a deck scuttle serves as a means of escape, it must not be less than 455 mm in diameter and must be fitted with a quick acting release and a holdback device to hold the scuttle in an open position.

4.5 Means of escape shall be clearly marked to aid with their identification and use in emergency situations.

5 Rails and guards

5.1 Rails or equivalent protection shall be installed near the periphery of all decks of a vessel accessible to passengers or seafarers. Equivalent protection may include lifelines, wire rope, chains and bulwarks that provide strength and support equivalent to fixed rails. Deck rails shall include a top rail with the minimum height of 1,000 mm and lower courses or equivalent protection. The distance between the lowest course and the deck shall not exceed 230 mm and the distance between the other courses shall not exceed 380 mm.

5.2 In a vessel fitted with a cockpit, which opens aft to the sea, additional guard-rails shall be fitted so that there is no unprotected vertical opening, i.e. between vertical “members,” greater than 500 mm in width.

5.3 In an inflatable boat, a rigid inflatable boat or similar boat, handgrips, toeholds and handrails shall be provided as necessary to ensure the safety of all persons on board during transit and the worst weather conditions likely to be encountered in the intended area of operation.

5.4 Suitable storm rails or hand grabs shall be installed where necessary in passageways, at deckhouse sides and at ladders and hatches.

5.5 On a vessel authorised to carry one or more vehicles, suitable sea fastening and securing devices, chains, cables or other barriers shall be installed at the end of each vehicle lane. Temporary rails or equivalent protection shall be installed where necessary in the way of each vehicle ramp when the vessel is underway.

PART B - WATERTIGHT AND WEATHERTIGHT OPENINGS

6 Hatchways

6.1 A hatchway, which gives access to spaces below the weather deck shall be of effective construction and be provided with efficient means of weathertight closure.

6.2 A cover to a hatchway shall be hinged, sliding, or permanently secured by other equivalent means to the structure of the vessel and be provided with devices to enable it to be positively secured in both the open and closed positions.

6.3 A hatchway with a hinged cover which is located in the forward portion of the vessel shall normally have the hinges fitted to the forward side of the hatch, as protection of the opening from boarding sea.

6.4 Hatches which are identified as forming part of a means of escape shall be capable of being opened from both sides.

6.5 Hatches which are required to be kept closed for safety reasons when the vessel is at sea shall have prominent “*WATERTIGHT HATCH - KEEP CLOSED*” warning notices attached to the vessel structure on both sides.

7 Hatches which are open at sea

7.1 Where operational needs exist for specified hatches to be open at sea for lengthy periods, these hatches shall be:

- .1** kept as small as practicable, but never more than 1 m² in plane area at the top of the coaming;
- .2** located at the centre line of the vessel or as close thereto as practicable and compatible with the proper working of the vessel; and
- .3** fitted such that the access opening is at least 300 mm above the top of the adjacent weather deck at the side of the vessel.

7.2 Spaces fitted with hatches which are open at sea for lengthy periods shall be provided with means for pumping out the affected space.

8 Doorways located above the weather deck

8.1 A doorway opening onto the weather deck which gives access to spaces below shall be provided with a weathertight door. The door shall be of efficient construction, permanently attached to the bulkhead, outward opening, and have efficient means of closure which can be operated from both sides. It shall be of equivalent strength to the structure in which it is fitted.

8.2 Doors fitted above the weather deck leading to the interior of the vessel shall be located as close as practicable to the centre line of the vessel and, where there are hinged doors located in the sides of a deckhouse, they shall be hinged on the forward side.

8.3 A doorway, which is either forward or side facing, shall be provided with a coaming, the top of which is at least 150 mm above the weather deck. A coaming may be portable provided it is permanently secured to the structure of the vessel and can be locked in position.

9 Companion hatch openings

9.1 A companion hatch opening from a cockpit or recess, which gives access to spaces below the weather deck shall be fitted with a coaming, the top of which is at least 300 mm above the sole of the cockpit or recess.

9.2 When washboards are used to close a vertical opening they shall be so arranged and fitted that they will not become accidentally dislodged.

9.3 The breadth of the opening of a companion hatch shall not exceed 1 m.

10 Skylights

10.1 A skylight on the weather deck, which gives access to spaces below, shall be fitted with a coaming, the top of which is at least 150 mm above the deck.

10.2 A skylight shall be of efficient weathertight construction and shall be located on the centre line of the vessel, or as near thereto as practicable. It may be further offset where necessary to provide a means of escape from a compartment below deck.

10.3 When a skylight is an opening type, it shall be provided with efficient means whereby it can be secured in the closed position from both sides.

10.4 In a vessel built after 1 July 2002 a skylight which is provided as a means of escape shall be capable of being opened from both sides.

10.5 Unless the glazing material and its method of fixing in the frame is equivalent in strength to that required for the structure in which it is fitted, a portable “blank” shall be provided which can be efficiently secured in place in event of breakage of the glazing. The blank shall be permanently located close to the skylight that it serves and shall be of suitable material and strength to the satisfaction of the Administration.

11 Portlights and windows

11.1 Any portlight or window that is fitted in the hull of a vessel below the weather deck shall have its sill no lower than 610 mm above the load waterline.

11.2 A portlight or window to a space below the weather deck or in a step, recess, raised deck structure, deckhouse or superstructure protecting openings leading below the weather deck shall be constructed to provide weathertight integrity, and be of strength compatible with size of the portlight or window, and the intended area of operation of the vessel. Glass and other glazing material used in windows shall be of a material that will not break into dangerous fragments if fractured.

11.3 Each window, port hole and its means of attachment to the hull or deck house shall be capable of withstanding the maximum load from wave and wind conditions expected due to its location on the vessel and the authorised operating area of the vessel.

11.4 In a vessel built after 1 July 2002, a portlight or window shall not be fitted in the main hull below the weather deck, unless the glazing material and its method of fixing in the frame are equivalent in strength to that required for the structure in which it is fitted.

11.5 In a vessel built after 1 July 2002, an opening portlight shall not be provided to a space situated below the weather deck.

11.6 In a vessel built after 1 July 2002 or in an existing vessel where a portlight or window is replaced, portlights, windows and their frames shall meet the requirements of ISO 12216 - Windows, portlights, hatches, deadlights and doors - strength and tightness requirements, or equivalent standard. This standard is recommended for vessels built before 1 July 2002.

11.7 In a vessel built after 1 July 2002 certified for operation in exposed waters, a portlight, fitted below the weather deck and not provided with an attached deadlight shall be provided with a “blank”, the number of blanks, shall be sufficient for at least half of the number of such portlights of each different size in the vessel, which can be efficiently secured in place in the event of breakage of the portlight. The blank shall be of suitable material and strength to the satisfaction of the Administration. Such a “blank” is not required for a non-opening portlight, which satisfies the requirements of **II/11.3**.

11.8 An opening portlight shall not exceed 250 mm in diameter or equivalent area.

11.9 In a vessel built before 1 July 2002 classed for operation in exposed waters, a window fitted in the main hull below the weather deck, shall meet the requirements of **II/11.3**, or be provided with a blank meeting the requirements of **II/11.7**.

11.10 For the wheelhouse:

- .1** Windows and other openings at the operating station shall be of sufficient size and properly located to provide an adequate view for safe navigation in all operating conditions;
- .2** windows and their frames shall meet the requirements of ISO 12216 (see **II/11.6**) or equivalent standard, having due regard to the increased thickness of windows comprising one or more laminations in order to achieve equivalent strength;
- .3** polarised or tinted glass shall not be used in windows provided for navigational visibility, although portable tinted screens may be provided for these windows; and
- .4** when a vessel is expected to operate in severe weather, relative to the size of the vessel, efficient storm shutters shall be provided for all front and side facing windows.

12 Ventilators

Ventilators that are fitted to provide ventilation to spaces below the weather deck shall be positioned as far inboard as possible and at a height above the weather deck sufficient to prevent the entry of water at any foreseeable angle of heel in service. Ventilators shall be fitted with means to prevent spray and rain from entering the spaces served.

PART C – ANTIFOULING

13 The International Convention on the Control of Harmful Anti-Fouling Systems on Ships prohibits the use of environmentally harmful organotins (for example Tributyl Tin) in antifouling paints applied on ships and prevents the possible use in the future of other harmful substances in anti-fouling systems. Organotin compounds were banned from 1st January 2008.

CHAPTER III FREEBOARD, STABILITY AND WATERTIGHT INTEGRITY

PART A - FREEBOARD

1 Minimum freeboard

1.1 The minimum freeboard shall not be less than the freeboard at which the vessel meets the stability requirements as determined by a recognized organization or competent person appointed by the Administration for the determination of such minimum freeboard after review and approval of the stability booklet or data. In approving the stability data or booklet, appropriate consideration shall be given to the standards of intact and damage stability as contained in the IMO International Code on Intact Stability 2008 (2008 IS Code), the type of vessel, its service and its area of operation. However, in all instances the minimum freeboard shall not be less than 250 mm. The minimum freeboard shall always be assigned measured and checked amidships. The deepest load waterline shall be the load-line equivalent to the minimum freeboard.

1.2 When demonstrating compliance with minimum assignments the freeboard shall be measured as follows:

- .1** For a flush deck or well deck vessel, the freeboard shall be measured to the top of the weather deck at the side of the vessel; and
- .2** For a cockpit vessel or for an open boat, the freeboard shall be measured to the top of the gunwale.

2 Loading marks

A vessel shall have permanent loading marks placed on each side of the vessel amidships to indicate the maximum allowable draft corresponding to the minimum freeboard determined according to regulation **III/1**. Such a loading mark shall be a horizontal line of at least 300 mm and 25 mm in height, with its upper edge passing through the point of maximum draft. The loading mark shall be painted in a contrasting colour to the sideshell paint.

3 Loading of a vessel

3.1 The loading mark amidships of a vessel shall not be submerged at any time when a vessel puts to sea, during a voyage or in port and the trim shall not exceed the maximum allowed trim as stated on the SCV Safety Certificate at **Annex 1**.

PART B – STABILITY

4 Stability information for operating personnel

Stability information, a stability letter or a stability booklet as determined by the Administration is required on all vessels. Sufficient stability information including stability calculations and assumptions

made to use them shall be provided on vessels for the master to be able to determine the stability of the vessel in various loading conditions in relation to accepted standards. Passenger vessels on international voyages in exposed waters⁴ must have an approved stability booklet.

5 Stability information

5.1 Where the Administration determines in accordance with **III/4**, that a vessel must have a stability booklet, the owner or operator shall prepare the booklet in accordance with **Annex 2A** and submit it to the Administration for approval.

5.2 All passenger vessels shall perform a light ship survey for confirmation of the light ship displacement on a five yearly basis in accordance with the procedure contained in the International Code on Intact Stability (IS Code 2008). This light ship survey shall be performed by a competent person or recognised organisation appointed by the Administration and the results shall be entered in the vessel's log book and stability information.

5.3 Where the Administration determines in accordance with **III/4**, that the stability information can be in the form of a stability letter the owner or operator of the vessel shall submit to the Administration the following information and the necessary calculations used to determine that information:

- .1** Proposed maximum allowable number of persons for each deck;
- .2** Deepest waterline drafts or freeboard;
- .3** Location of watertight bulkheads and openings in watertight bulkheads;
- .4** Drawings of the vessel's subdivision bulkheads and specific identification of the vessel's tank spaces and compartments;
- .5** Location of openings through watertight bulkheads, such as watertight doors, which must be closed to limit flooding in an emergency;
- .6** Location, type and amount of fixed solid ballast, if applicable;
- .7** Location and details of flotation material; and
- .8** Details of any lifting appliances, portable equipment including diving equipment or any cargo for normal loading and offloading.

6 Intact stability requirements in general

6.1 A new vessel should undergo an inclining test in accordance with the International Code on Intact Stability 2008 (2008 IS Code) in the presence of an Administration surveyor. The Administration

⁴Passenger vessels to which this Code applies must operate within 20 miles of the nearest harbour or safe refuge.

may accept a simplified stability proof test in accordance with regulation **III/8** performed in the presence of an Administration surveyor where there is doubt as to the authenticity or accuracy of stability data submitted in accordance with regulation **III/5.3**.

6.2 A simplified stability proof test in accordance with regulation **III/8** and **Annex 2** is to be performed on an existing vessel where there is doubt as to the authenticity or accuracy of stability data submitted in accordance with regulation **III/5.3**.

6.3 The stability of a vessel certified to operate in exposed waters shall always be determined by calculation in accordance with IMO International Code on Intact Stability 2008 (2008 IS Code) or other proven method for a range of loading conditions to the satisfaction of the Administration.

6.4 In the instance where an existing ship operating in coastal or protected waters cannot supply adequate drawings or data to the Administration for review and approval the following can be considered for the issuance of a stability letter by the Administration:

- .1** Objective evidence of continuous service over a period of not less than five years, from the date of the initial survey. If the vessel carries passengers that the normal service of the vessel has been performed without accident or incident related to the stability or structural integrity of the vessel;
- .2** Objective evidence in the instance of either a cargo or passenger ship that during the five years of service, immediately before the date of initial survey, voyages were performed with the vessel in a range of loading conditions from fully loaded with cargo, passengers and stores/consumables to the carriage of minimal stores/consumables, cargo and passengers;
- .3** Objective evidence that by operational experience over a five-year period, immediate to the date of initial survey, an operating loaded draft or minimum freeboard and light draft and maximum freeboard has been established and documented;
- .4** Confirmation of the light ship weight or displacement of the vessel;
- .5** Sufficient data to demonstrate to the administration in so far that is reasonable and practical that the weight or content of all ballast tanks and tanks containing consumable liquids is known and properly documented; or
- .6** Documentation plans, drawings or data to justify or substantiate the carriage of any solid or permanent ballast.

Upon submission of the aforementioned information in whole or in part, the Administration or recognized organization or appointed competent person shall review the data and based on the vessels operations and configuration, either issue a stability letter giving specific details of the approval parameters and or perform a simplified stability test to verify the submissions before approval. Special consideration can be given to information contained in official records such as ship log books or previous flag information.

7 Intact stability requirements for a sailing vessel

7.1 Subject to **III/7.3**, each sailing vessel shall undergo a simplified stability proof test in accordance with regulation **III/8**.

7.2 A sailing vessel that operates in coastal or exposed waters shall be equipped with a self-bailing cockpit or equivalent arrangements.

7.3 The Administration may perform operational tests to determine whether the vessel has adequate stability and satisfactory handling characteristics under sail for protected waters or coastal waters, in lieu of conducting a simplified stability proof test.

7.4 The Administration may prescribe additional or different stability requirements for a broad, shallow draft vessel with little or no ballast tanks.

8 Simplified stability proof test procedure and assumptions

8.1 A vessel shall be in the condition specified in **III/8.2** to **III/8.9** inclusive when a simplified stability proof test is performed.

8.2 The vessel shall be moored in a quiet, sheltered area free from extraneous forces such as propeller wash from passing vessels, or sudden discharges from shore-side pumps, and in a manner to allow unrestricted heeling.

8.3 The construction of the vessel shall be complete in all respects.

8.4 Ballast, where necessary, shall be in compliance with regulation **III/9** and shall be on board and in place.

8.5 Each fuel and water tank shall be approximately three-quarters full.

8.6 A weight equal to the total weight of all persons and other loads permitted on the vessel shall be on board and distributed so as to provide normal operating trim and to simulate the vertical centre of gravity causing the least stable condition that is likely to occur in service. Care shall be taken to ensure the safety of all personnel during this operation with appropriate risk assessments being undertaken prior to commencement of loading weights. For the purposes of regulation **III/8** seafarers shall be counted as passengers.

8.7 Unless otherwise specified, weight and vertical centre of gravity is assumed to be as follows:

- .1** the weight of primary lifesaving equipment shall be simulated at its normal location, if not on board at the time of the test;
- .2** the weight of one person is considered to be 82.5 kg;
- .3** the vertical centre for the simulated weight of passengers, seafarers, and other loads shall be at least 760 mm above the relevant deck; and
- .4** where the vessel carries passengers on diving excursions, the total weight of diving gear shall be included in the loaded condition, in the positions they would normally be carried, as follows:

- .1 the total weight of individual diving gear for each passenger carried is assumed to be 36 kg, which includes the weight of scuba tanks, harness, regulator, weight belt, wet suit, mask, and other personal diving equipment; and
- .2 the weight of any air compressors carried.

8.8 On vessels having one upper deck above the main deck available to passengers, the vertical weight distribution shall not be less than the following:

$$\text{Weight on Upper Deck} = (\# \text{ of passengers on upper deck}) \times (\text{Wt per passenger}) \times 1.33$$

$$\text{Weight on Main Deck} = \text{Total Test Weight} - \text{Weight on Upper Deck}$$

8.9 All non-return closures on cockpit scuppers or on weather deck drains shall be kept open during the test.

8.10 A vessel shall not exceed the limitations in **III/8.12**, when subjected to the greater of the following heeling moments:

$$M_p = (W)(B_p)/6; \text{ or}$$

$$M_w = (P)(A)(H)$$

where:

M_p = passenger heeling moment in kilogram-metres

W = the total passenger weight using 82.5 kg per passenger

B_p = the maximum transverse distance in metres of a deck that is accessible to passengers

M_w = wind heeling moment in kilogram-metres

P = wind pressure of:

- (a) 36.6 kilograms/square metre for operation on protected waters;
 - (b) 48.8 kilograms/square metre for operation on coastal waters;
- or
- (c) 73.3 kilograms/square metre for operation on exposed waters;

A = area, in square metres of the projected lateral surface of the vessel above the waterline, including each projected area of the hull, superstructure and area bounded by railings and structural canopies. For sailing vessels this is the bare poles area, or, where the vessel has

no auxiliary power, with storm sails set; and

H = height, in metres of the centre of area (A) above the waterline, measured up from the waterline.

8.11 For sailing vessels the heeling moment used for this test shall be the greater of the following:

- .1 Passenger heeling moment from **III/8.10**.
- .2 Wind heeling moment from **III/8.10**.
- .3 Wind heeling moment calculated from the wind heeling moment equation in **III/8.10** as $M_w = (P)(A)(H)$,
where:

M_w = wind heeling moment in kilogram-metres

P = 4.9 kilograms/square metre;

A = the windage area of the vessel in square metres with all sails set and trimmed flat;
and

H = height, in metres of the centre of effort of area (A) above the waterline, measured up from the waterline.

8.12 When a vessel is subjected to the greater of the heeling moments determined in regulation **III/8.10**, the immersion of the loading mark shall not exceed the percentage of the freeboard specified in the following:

- .1 on a flush deck vessel, 50 per cent;
- .2 on a well deck vessel that operates on protected waters and has non-return scuppers or freeing ports, 100 per cent where the full freeboard is not more than one-quarter of the vertical distance from the waterline to the gunwale;
- .3 on all other well deck vessels, 50 per cent;
- .4 on a cockpit vessel, the percentage is calculated from the following:

on exposed waters: $(2L - 1.5LN)/4L$;

on protected or coastal waters: $(2L - LN)/4L$;

where:

L = length of the vessel as defined in regulation **I/2.28**; and

LN = length of cockpit in the same units as L;

- .5 on an open boat, 25 per cent; and

.6 on a flush deck sailing vessel, 100 per cent.

8.13 Notwithstanding the percentages specified in regulation **III/8.12**, when the vessel is subject to the greater of the heeling moments determined in regulation **III/8.10**, the immersion shall not exceed a value equivalent to one eighth of the beam of the vessel measured at the point of minimum freeboard as defined in regulation **III/1.1**.

8.14 Where during a simplified stability proof test a vessel fails to meet the requirements of regulations **III/8.12** and **III/8.13**, the entire test shall be repeated with a reduced load equivalent to a reduced number of passengers or a reduced weight of cargo or by utilizing any other corrective measures available to enable the vessel to meet the requirements of regulations **III/8.12** and **III/8.13**.

8.15 A ferry shall also be tested by using equivalent weights, by calculation, or other method acceptable to the Administration to determine whether the trim or heel during loading or unloading will submerge the deck edge. A ferry passes this test where, with the total number of passengers and the maximum vehicle weight permitted on board, the deck edge is not submerged during loading or unloading of the vessel.

8.16 The Small Commercial Vessel Stability Test Procedure is given in **Annex 2**.

9 Installation of ballast

Any solid fixed ballast shall be stowed in a manner that prevents shifting of the ballast and be installed to the satisfaction of the Administration.

10 Open boats

An open boat when fully loaded shall have sufficient buoyancy to be able to remain afloat and should have a positive metacentric height, that is, the vessel returns to the upright when a heeling moment is applied and removed, when totally flooded. The open boat shall be deemed by the Administration to have sufficient buoyancy by practical test or where detailed calculations are confirmed to show that the buoyancy of the vessel is greater than the total weight of the vessel and its load.

11 Foam flotation material

11.1 Foam may only be installed as flotation material on a vessel when approved by the Administration.

11.2 Where foam is installed as flotation material on a vessel, the owner shall ensure that the following tests are conducted and requirements are met to the satisfaction of the Administration:

- .1 foam shall not be installed in void spaces that contain ignition sources;
- .2 foam shall not be installed adjacent to fuel tanks, unless the boundary between the tank and the space has double continuous fillet welds;
- .3 the structure enclosing foam shall be strong enough to accommodate the buoyancy of

the foam, void spaces filled with foam should be fully coated if vessel is of steel or aluminium construction;

- .4 piping and cables shall not pass through foamed spaces unless they are within piping and cableways accessible from both ends;
- .5 blocked foam shall:
 - .1 be used in each area that may be exposed to water; and
 - .2 have a protective cover, approved by the Administration, to protect it from damage;
- .6 foam used as floatation material shall be:
 - .1 impervious to water absorption;
 - .2 structurally stable under service conditions;
 - .3 chemically inert in relation to other medium with which it may be in contact;
 - .4 properly secured in place; and
 - .5 easily removable for inspection of the void space.
- .7 a water submergence test shall be conducted on the foam for a period of at least 7 days to demonstrate to the satisfaction of the Administration that the foam has adequate strength to withstand a hydrostatic head equivalent to that which would be imposed if the vessel were submerged to its bulkhead deck; and
- .8 the owner or operator shall obtain sample foam specimens during installation of the foam and determine the density of the installed foam.

PART C - WATERTIGHT INTEGRITY

12 Drainage of weather decks

12.1 The weather deck on all vessels shall be watertight or fitted with closures to ensure watertight integrity. The drainage from the weather deck shall be such that the watertight integrity is not compromised.

12.2 When a deck is fitted with bulwarks such that shipped water may be trapped, the bulwarks shall be provided with efficient freeing ports.

12.3 The area of freeing ports shall be at least 5% of the bulwark area and be situated in the lower third of the bulwark height, the bottom of which shall be flush with the deck.

12.4 A vessel of less than 12 m in length overall, certified to operate in coastal waters, having a well deck aft and is fitted with bulwarks all round and which always operates with stern trim, may be provided with a minimum of two ports fitted (one port and one starboard) in the transom, each having a clear area of at least 225 cm².

12.5 Where a non-return shutter or flap is fitted to a freeing port it shall have sufficient clearance to prevent jamming and any hinges shall have pins or bearings of non-corrodible material. Normally, hinges shall be along the upper edge of the non-return shutter or flap.

12.6 Where a vessel has side deck areas of less than one-tenth the length of the vessel, in which water can be trapped a smaller freeing port area may be accepted. The reduced area shall be based on the volume of water, which is likely to become trapped.

12.7 In a vessel in which freeing ports cannot be fitted, other efficient means of clearing trapped water from the vessel shall be provided to the satisfaction of the Administration.

12.8 Structures and spaces considered non-weathertight shall be provided with efficient drainage arrangements.

12.9 Where cargo is to be stowed on deck the stowage arrangement shall be such as to not impede the free flow of water from the deck.

13 Air pipes

13.1 When located on the weather deck, air pipes shall be kept as far inboard as possible and have a height above deck sufficient to prevent downflooding when heeled in rough water.

13.2 Any air pipe which terminates at a height such that it would be submerged at any angle up to the vessel's angle of downflooding, shall be fitted with a means to automatically prevent water ingress while permitting the air pipe to continue to function. Air pipes that terminate at a height such that they are not submerged at the angle of downflooding shall be arranged so that they have protection against water ingress from rain or spray.

14 Sea inlets and discharges

14.1 An opening below the weather deck shall be provided with an efficient means of closure.

14.2 When the opening is for the purpose of an inlet or discharge below a line drawn 150 mm above the loading mark it shall be fitted with a seacock, valve or other positive means of closure, which is readily accessible in an emergency.

14.3 When the opening is for a log or other sensor, which is capable of being withdrawn, it shall be fitted in an efficient watertight manner and provided with an effective means of closure when such a fitting is removed.

14.4 Inlet and discharge pipes from water closets (toilets) shall be provided with shell fittings as required by **III/14.1** and **III/14.2**. When the rim of a toilet is less than 300 mm above the deepest waterline of the vessel, anti-syphon measures shall be provided.

15 Materials for valves and associated piping

15.1 A valve or similar fitting attached to the side of the vessel below the waterline, shall be normally of steel, bronze or other non-brittle fire resistant material or equivalent. Valves of ordinary cast iron or similar material are not acceptable.

15.2 When plastic piping is used it shall be of good quality and of a type suitable for the purpose. Any such pipe shall be located so as to minimise the risk of accidental damage. Where fitted within an engine space or fire risk area, a means shall be provided to stop the ingress of water in the event of the pipe being damaged, operable from outside the space.

PART D – SUBDIVISION**16 Collision bulkheads**

16.1 A vessel of 20 m or more in length overall built after 1 July 2002 is required to have a collision bulkhead fitted in accordance with regulations **III/17.1** and **III/17.2**.

16.2 A vessel of less than 20 m in length overall built after 1 July 2002 shall have a collision bulkhead where it:

- .1** is an existing vessel certified to carry 50 or more passengers;
- .2** is a new vessel certified to carry 12 or more passengers;
- .3** is of more than 12 m in length and is certified to operate on coastal waters; or
- .4** is certified to operate on exposed waters.

16.3 A ro-ro ferry of 20 m or more in length overall that may operate on its route ahead or astern shall, in addition to the collision bulkhead required by **III/16.1** is required to have a collision bulkhead fitted in accordance with regulations **III/17.1** and **III/17.3**.

16.4 The Administration shall determine the extent to which this regulation is applied to existing vessels. Such determination should be noted in the remarks section of the SCV Safety Certificate.

17 Construction and location of collision bulkheads

17.1 Each collision bulkhead required by regulation **III/16** shall be constructed in accordance with regulation **III/18** except that it shall:

- .1** extend to the weather deck or to one deck above the bulkhead deck, whichever is lower, in vessels certified to operate on coastal and exposed waters; and
- .2** not be fitted with any type of penetration or opening except penetrations may be made where they are located as high and as far inboard as practicable and they have a means

to make them watertight.

17.2 The forward collision bulkhead required to be on a vessel by regulation **III/16** shall be:

- .1** located at least 5% but not more than 15% of the length between perpendiculars (LBP) aft of the forward perpendicular or for vessels with bulbous bows extending forward of the forward perpendicular and contributing more than 2% of the underwater volume of the vessel the bulkhead shall be located at least 5% but not more than 15% of the LBP aft of the mid-length of such extension; and
- .2** installed in a single plane, with no recess or step, up to the bulkhead deck.

17.3 The after collision bulkhead on a double-ended ferry of 20 m or more in length overall required by regulation **III/16.3** shall be:

- .1** located at least 5% but not more than 15% of the LBP forward of the after perpendicular; and
- .2** installed in a single plane, with no recess or step, at least up to the bulkhead deck.

18 Watertight subdivision bulkheads

18.1 Where a vessel is required to be fitted with watertight collision or subdivision bulkheads, each watertight bulkhead shall be of sufficient strength to be capable of remaining watertight with a head of water to the top of the bulkhead.

18.2 Each watertight bulkhead shall extend to the bulkhead deck and shall be installed in one plane without steps or recesses insofar as is reasonable and practicable. Any steps or recesses permitted shall comply with the applicable subdivision requirements in this chapter.

18.3 The number of penetrations in a watertight bulkhead shall be minimised. A penetration in a watertight bulkhead shall be as high and as far inboard in the bulkhead as practicable, and made watertight.

18.4 Sluice valves shall not be permitted in watertight bulkheads.

18.5 A door fitted in a watertight bulkhead shall be of watertight construction and be kept closed at sea, unless opened at the discretion of the Master.

18.6 In new vessels the indication of door status should be provided at the operating station.

18.7 The Administration shall determine the extent to which this regulation is applied to vessels built before 1 July 2002.

19 Subdivision of cargo vessels

A cargo vessel of 12 m or more in length overall built after 1 July 2002 shall be fitted with watertight

bulkheads at each end of the main propulsion machinery space.

20 Subdivision of passenger vessels

20.1 A passenger vessel of 20 m or more in length overall built after 1 July 2002 shall be fitted with watertight bulkheads fitted in accordance with regulation **III/21**.

20.2 A passenger vessel of less than 20 m in length overall built after 1 July 2002 shall have watertight bulkheads in accordance with regulation **III/21**, where it:

- .1 carries 50 or more passengers, in a new vessel 12 or more passengers;
- .2 is of more than 12 m in length overall and is certified to operate on coastal waters; or
- .3 is certified to operate in exposed waters⁵.

21 Location of watertight bulkheads for subdivision

21.1 The maximum distance between adjacent main transverse watertight bulkheads on a vessel, required by regulation **III/20** to comply with this regulation, shall not be more than the smaller of the following:

- .1 one third of the length of the bulkhead deck; or
- .2 the distance given by the following equation:

$$d = \frac{(F)(f)(L)}{D}$$

where:

F = the floodable length factor from **Table III/21**;

f = the effective freeboard in metres calculated for each pair of adjacent bulkheads in accordance with **III/21**;

L = Length Over Deck in metres measured over the bulkhead deck; and

D = the depth in metres, measured amidships at a point one-quarter of the maximum beam out from the centreline, from the inside of the bottom planking or plating to the level of the top of the bulkhead deck (See **Figure III/21-1**).

⁵Passenger vessels to which this Code applies must operate within 20 miles of the nearest harbour or safe refuge.

**TABLE III/21
TABLE OF FLOODABLE LENGTH FACTORS**

(d/L)x100	F
0-15	0.33
20	0.34
25	0.36
30	0.38
35	0.43
40	0.48
45	0.54
50	0.61
55	0.63
60	0.58
65	0.53
70	0.48
75	0.44
80	0.40
85	0.37
90-100	0.34

NOTE 1: Where:
d = distance in metres from the midpoint of the compartment to the forward most point on the bulkhead deck excluding sheer; and
L = length over deck in metres measured over the bulkhead deck.

NOTE 2: Intermediate values of floodable length factor may be obtained by interpolation.

Figure III/21-1

Transverse Location for Measuring Depth(D)

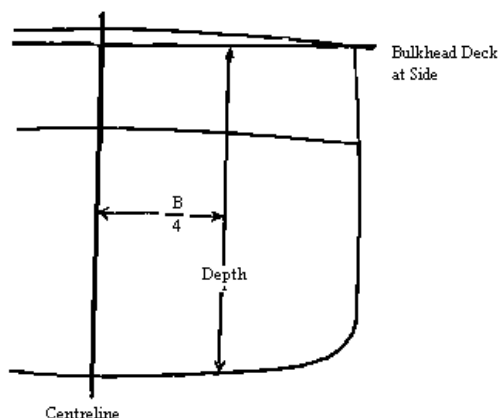

21.2 The effective freeboard for each compartment is calculated by the following equation:

$$f = (a+b)/2$$

where:

f = the effective freeboard in metres.

a = the freeboard in metres measured:

- .1 at the forward main transverse watertight bulkhead; and
- .2 from the deepest waterline to:
 - .1 the top of the bulkhead deck on a flush deck vessel; and
 - .2 where a vessel has a stepped bulkhead deck, then to the line shown in **Figure III/21-2**; or
 - .3 where a vessel has an opening scuttle (porthole) below the bulkhead deck, then to the line shown in **Figure III/21-3**.

b = the freeboard in metres measured:

- .1 at the aft main transverse watertight bulkhead; and
- .2 from the deepest waterline to:
 - .1 the top of the bulkhead deck on a flush deck vessel;
 - .2 where a vessel has a stepped bulkhead deck, the line shown in **Figure III/21-2**;
or
 - .3 where a vessel has an opening scuttle (porthole) below the bulkhead deck, the line shown in **Figure III/21-3**.

Figure III/21-2

Freeboard Measurement - Vessel with Stepped Bulkhead Deck

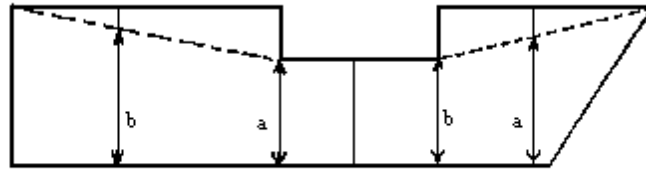

(a and b shown for two sample compartments)

Figure III/21-3

Freeboard Measurement - Vessel with Stepped Bulkhead Deck and a Porthole Below the Bulkhead Deck

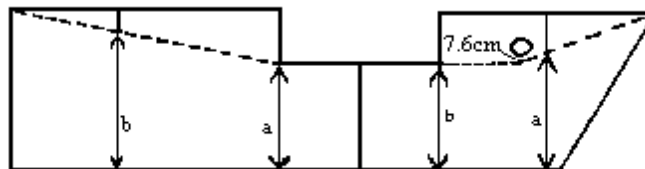

21.3 A vessel, required by regulation **III/20** to be fitted with watertight bulkheads shall be measured and subdivided in accordance with the simplified subdivision calculation given in **Annex 3**.

**CHAPTER IV
MACHINERY****PART A – GENERAL PROVISIONS****1 General requirements**

1.1 The design, construction, installation and operation of propulsion and auxiliary machinery, piping and pressure systems, steering apparatus and associated safety systems shall be to the satisfaction of the Administration. These requirements shall be considered to be satisfactory where they are in accordance with the requirements of a classification society recognised by the Administration.

1.2 In all vessels, the main propulsion machinery and all auxiliary machinery essential to the propulsion and the safety of the vessel shall as fitted in the vessel, be in good working order, designed to operate when the vessel is upright and when inclined at any angle of heel up to and including 15° either way under static conditions and in the case of new vessels 22.5° either way under dynamic conditions (rolling) and simultaneously inclined dynamically (pitching) 7.5° by bow or stern.

1.3 In new vessels no direct connections shall be allowed in the ventilation system between machinery spaces and accommodation or galley spaces.

1.4 Starting motors, generators, and any spark producing device shall be mounted as high above the bilges as practicable. Electrical equipment in spaces, compartments, or enclosures that contain machinery powered by, or fuel tanks for, gasoline or other fuels having a flashpoint of 43°C or lower shall be explosion-proof, intrinsically safe, or ignition protected for use in a gasoline atmosphere.

1.5 Gauges to indicate engine revolutions per minute (RPM), jacket water discharge temperature, and lubricating oil pressure shall be provided for all propulsion engines installed in the vessel. The gauges shall be readily visible at the operating station.

1.6 A cover, guard or rail shall properly protect an exposed hazard, such as gears or rotating machinery.

1.7 Shutoff valves, installed so as to close against the fuel flow, shall be fitted in the fuel supply lines:

.1 One valve at the tank connection and one at the engine end of the fuel line to stop fuel flow when servicing accessories. The shutoff valve at the tank shall be manually operable, preferably from an accessible position on the weather deck, but it may be at the tank where the tank is situated outside the machinery space; and

.2 Where the handle to the shutoff valve at the fuel tank is located inside the machinery space the shut off valve shall be arranged so that it can be easily operated manually from outside the machinery space when all openings to the space are closed.

1.8 Fuel filling and venting pipes shall be constructed of fuel compatible non-kinking material, adequately supported and of sufficient dimensions to prevent spillage during filling. A venting pipe shall

be led to the open atmosphere, terminating in a position level with or higher than the fuel filling mouth and its open end protected against:

- .1 water ingress - by a goose neck or other efficient means; and
- .2 flame ingress - by a suitable gauze diaphragm, which can be detached for cleaning.

1.9 An air pipe, of greater than 10 mm inside diameter, serving a fuel tank or other tank shall be provided with a closing appliance of a type, which will prevent excessive pressure on the tank boundaries. Provision shall be made for relieving a vacuum when tanks are being drawn from or emptied.

1.10 Flexible non-metallic hose shall only be permitted in positions where fixed pipes are difficult to fit or is necessary due to flexible mountings of machinery subject to the following:

- .1 when required by the machinery manufacturer, factory-assembled fittings shall be used;
- .2 hose clamps may be used for other installations of short lengths not to exceed 760 mm and subject to pressures of not more than 35 kPa;
- .3 in a fuel supply system to an engine unit the hose shall be of an approved type and fire resistant/metal reinforced or otherwise protected from fire; and
- .4 they shall be installed and located so as to minimize the risk of accidental damage.

1.11 In systems and applications where flexible hoses are permitted to be clamped by regulation IV/1.10:

- .1 double hose clamping is required;
- .2 the clamps shall be of a corrosion resistant metallic material; and
- .3 the clamps shall not depend on spring tension for their holding power.

1.12 An enclosed space containing machinery powered by gasoline or other fuels, having a flash point of 43°C or lower, shall be equipped with a flammable vapour detection device.

1.13 Piping used in the following systems shall be of ferrous material or other⁶ material providing an equivalent standard of safety approved by the Administration.

- .1 Fuel system;
- .2 Fire main;

⁶Resolution MSC.313(88) - Amendments to the guidelines for the application of plastic pipes on ships (Resolution A.753(18)).

- .3 CO₂ system fixed firefighting;
- .4 Bilge system;
- .5 Steering system;
- .6 Propulsion system and its necessary auxiliaries and controls;
- .7 Vessel's service and emergency electrical generation system and its necessary auxiliaries; and
- .8 A system identified by the Administration as being crucial to the survival of the vessel or to the protection of the personnel on board.

1.14 The location of fuel oil piping through the accommodation spaces and/or water tanks shall be avoided as far as practicable on existing vessels and is not allowed on new vessels.

1.15 Diesel tanks may only be integral with the hull structure where the vessel is made of steel, or aluminium. FRP, sandwich construction is not acceptable. All other fuel tanks shall be independent of the hull.

1.16 Independent fuel tanks shall comply with the following:

- .1 the tank shall be constructed of steel or aluminium;
- .2 sight glass shall be of an approved type, fitted only to a diesel tank and shall be of heat resistant material, protected from mechanical damage, and provided with self-closing valves between the sight glass and tank;
- .3 where any dimension of the tank exceeds 760 mm, the tank shall be fitted with baffle plates to maintain strength and control the excessive surge of fuel; and
- .4 cylindrical sight gauge glasses shall not be allowed in new vessels.

1.17 Fuels tanks shall be pressure tested to 30 kPa.

1.18 Fuel tanks shall be electrically bonded to a common ground.

1.19 Fuel tanks shall be adequately supported and braced to prevent movement.

1.20 For new vessels a fuel tank shall be provided with a sample point, positioned as near to the tank bottom as possible, to check the presence of water and with the possibility to drain water from the tank.

2 Gasoline engines for propulsion

2.1 Inboard engines fuelled by fuel with a flash point of less than 43°C are not permitted.

2.2 Notwithstanding **IV/2.1**, an existing vessel already fitted with an inboard gasoline engine may be allowed to continue in operation provided that:

- .1** the engine is located in an efficiently enclosed space to which a fixed fire extinguishing system is fitted;
- .2** provision is made to ventilate the engine space thoroughly before the engine is started;
- .3** electrical devices within the engine and tank compartments have protection against ignition of surrounding flammable gasses;
- .4** any flexible hose used between the engine and any solidly mounted metallic line to eliminate vibration failure is made of fire resistant fuel hose or otherwise protected from fire;
- .5** not more than 12 passengers are carried;
- .6** the vessel is certified to operate only in protected or coastal waters; and
- .7** fuel quantities carried shall be in a limited quantity reflecting that required to safely undertake the voyage.

2.3 A replacement engine for an existing vessel fitted with an inboard gasoline engine shall not be a gasoline engine.

3 Outboard engines

3.1 Vessels fitted with gasoline or diesel outboard engines shall:

- .1** be certified to operate in protected and coastal waters only;
- .2** have the engines securely fastened to the hull;
- .3** have effectively drained engine wells that are long enough for the engine to be tilted up;
- .4** where the vessel is fitted with a single outboard engine and where it proceeds beyond protected waters, have an auxiliary outboard engine of sufficient power to enable the vessel to return safely to port or a safe refuge; and
- .5** carry a limited quantity of fuel reflecting that required to safely undertake the voyage.

3.2 Gasoline for outboard motors shall be stored:

- .1** in portable containers that can be readily jettisoned; or

- .2 in a fixed-in-place inboard tank independent of the hull, where:
 - .1 the vessel is a rigid hulled vessel or rigid/inflatable boat;
 - .2 the tank is constructed of mild steel or stainless steel or aluminium and located in a safe place;
 - .3 the tank is tested to a pressure of 30 kPa, to the satisfaction of a surveyor;
 - .4 the opening of the vent pipe from the gasoline tank is protected by a flash proof fitting; and
- .3 electrical devices within the engine and fuel tank compartments shall be protected against ignition of any surrounding flammable gasses (explosion proof).

3.3 Where the possibility of accumulation of hydrocarbon vapours exists and where a source of ignition may be present a fixed in place inboard gasoline tank is not allowed.

4 Ventilation of spaces relating to gasoline

4.1 A space containing machinery powered by, or fuel tanks for, gasoline shall have a ventilation system that complies with this regulation and consist of the following:

- .1 For an enclosed space:
 - .1 at least two natural ventilation supply ducts located at one end of the space that extend to the lowest part of the space or to the bilge on each side of the space; and
 - .2 a mechanical exhaust system consisting of at least two ventilation exhaust ducts located at the end of the space opposite from where the supply ducts are fitted, which extend to the lowest part or the bilge of the space on each side of the space, and which are led to one or more powered exhaust blowers.
- .2 For a partially enclosed space, at least one ventilation duct installed in the forward part of the space and one ventilation duct installed in the after part of the space, or as otherwise required by the Administration. Ducts for partially enclosed spaces shall have cowls or scoops as required by **IV/4.9**.

4.2 A mechanical exhaust system required by regulation **IV/4.1.1.2** shall be such as to assure the air changes as noted in **Table IV/4.2** depending upon the size of the space.

TABLE IV/4.2

Size of space in cubic metres		Minutes per air change
Over	Not over	
0	14	2
14	28.5	3
28.50	43	4
43	5

4.3 An exhaust blower motor where mounted in any space required to be ventilated by this regulation, shall be located as high above the bilge as practicable. Blower blades shall be non-sparking with reference to their housings.

4.4 Where a fixed gas fire extinguishing system is installed in a space, all powered exhaust blowers for the space shall automatically shut down upon release of the extinguishing agent.

4.5 Exhaust blower switches shall be located outside of any space required to be ventilated by this regulation, and shall be of the type interlocked with the starting switch and the ignition switch so that the blowers are started before the engine starter motor circuit or the engine ignition is energised. A red warning sign at the switch shall state that the blowers shall be operated prior to starting the engines for the time sufficient to insure at least one complete change of air in the space served.

4.6 The area of the ventilation ducts shall be sufficient to limit the air velocity to a maximum of 10 m/s. A duct may be of any shape, provided that in no case will one cross sectional dimension exceed twice the other.

4.7 A duct shall be of rigid permanent construction, which does not allow any appreciable vapour flow except through normal openings, and made of the same material as the hull or of non-combustible material. The duct shall lead as directly as possible from its intake opening to its terminus and be securely fastened and supported.

4.8 A supply duct shall be provided at its intake opening with a cowl or scoop having a free area not less than twice the required duct area. When the cowl or scoop is screened, the mouth area shall be increased to compensate for the area of the screen wire. A cowl or scoop shall be kept open at all times, except when the weather is such as to endanger the vessel if the openings are not temporarily closed.

4.9 A duct opening shall not be located:

- .1** where the natural flow of air is unduly obstructed;
- .2** adjacent to possible sources of vapour ignition;
- .3** where exhaust air may be taken into a supply duct; and
- .4** where the ordinary collection of water in the bilge will not block air flow.

4.10 Provision shall be made for closing all supply duct cowls or scoops and exhaust duct discharge openings for a space protected by a fixed gas extinguishing system. All closure devices shall be readily available and mounted in the vicinity of the vent and to be operated from outside the protected space.

5 Ventilation of spaces relating to diesel

5.1 A space containing diesel machinery shall be fitted with at least two ducts to furnish natural or powered supply and exhaust ventilation. The total inlet area and the total outlet area of each ventilation duct shall not be less than 650 mm² for each 300 cm of beam of the vessel. These minimum areas shall be increased as necessary when the ducts are considered as part of the air supply to the engines.

5.2 A duct shall be of rigid permanent construction, which does not allow any appreciable vapour flow except through normal openings, and made of the same material as the hull or of non-combustible material. The duct shall lead as directly as possible from its intake opening to its terminus and be securely fastened and supported.

5.3 A supply duct shall be provided at its intake opening with a cowl or scoop having a free area not less than twice the required duct area. When the cowl or scoop is screened, the mouth area shall be increased to compensate for the area of the screen wire. A cowl or scoop shall be kept open at all times, except when the weather is such as to endanger the vessel if the openings are not temporarily closed.

5.4 Fire Dampers shall be fitted to all ducts serving areas which are fitted with fixed gas fire extinguishing systems.

5.5 A duct opening shall not be located:

- .1** where the natural flow of air is unduly obstructed;
- .2** adjacent to possible sources of vapour ignition;
- .3** where exhaust air may be taken into a supply duct; and
- .4** where the ordinary collection of water in the bilge will not block air flow.

5.6 Where a fixed gas fire extinguishing system is installed in a space, all powered exhaust blowers for the space shall automatically shut down upon release of the extinguishing agent.

5.7 Provision shall be made for closing all supply duct cowls or scoops and exhaust duct discharge openings for a space protected by a fixed gas extinguishing system. All closure devices shall be readily available and mounted in the vicinity of the vent.

5.8 A space containing a diesel fuel tank and no machinery shall meet the following requirements:

- .1** A space of 14 m³ or more in volume shall have a gooseneck vent of not less than 65 mm in diameter.

- .2 A space of less than 14 m³ in volume shall have a gooseneck vent of not less than 40 mm in diameter.
- .3 Vent openings shall not be located adjacent to possible sources of vapour ignition.

6 Exhausts

6.1 An engine exhaust outlet, which penetrates the hull below the weather deck, shall be provided with means to prevent backflooding into the hull through the exhaust system. The means may be provided by system design or arrangement, built-in valve or a portable fitting, which can be applied readily in an emergency.

6.2 Engine exhaust outlets shall be insulated. Where exhaust piping is installed near high pressure fuel lines the insulation shall be impervious to oil.

7 Engine starting

7.1 An engine shall be provided with either:

- .1 hand starting;
- .2 mechanical;
- .3 electric starting with independent batteries installed in accordance with regulation IV/21; or
- .4 other means of starting acceptable to the Administration.

7.2 When the sole means of starting is by battery, the battery shall be installed in accordance with regulation IV/21 and be in duplicate and connected to the starter motor by means of a “change over switch” so that either battery or both can be used for starting the engine. In normal circumstances, the use of both batteries in parallel should be avoided to prevent simultaneous discharge of both batteries. Charging facilities shall be available for the batteries when the engine is running.

8 Portable plant

8.1 Any portable plant provided on board powered by a gasoline engine shall be fitted on the weather deck and properly secured to prevent movement.

8.2 A deck locker or protective enclosure for the portable plant shall have no openings to an enclosed space within the hull of the vessel and the locker or protective enclosure shall be adequately ventilated and drained.

8.3 Gasoline tanks provided for the engine shall comply with the following:

- .1 fuel is supplied to the engine from a portable tank of 27 litres or less in capacity complying with the requirements of ISO 13591 - Portable fuel systems for outboard

motors – or its equivalent National Standard; and

- .2 a marine gasoline engine, of less than 3.75 kW, manufactured with an integral fuel tank is acceptable for either outboard propulsion or portable plant provided a safety warning sign is displayed with details of appropriate precautions to be taken when filling the fuel tank.

9 Propulsion engine control systems

9.1 A new vessel shall have a means for control and shutting down a propulsion engine at the location of the engine.

9.2 A vessel shall have a reliable means for shutting down a propulsion engine, at the main operating station, which is independent of the engine's speed control.

9.3 A propulsion engine control system, including control at the operating station, shall be designed so that a loss of power to the control system does not result in an increase in shaft speed or propeller pitch.

PART B - STEERING AND PROPELLER SYSTEMS

10 Main steering gear

10.1 A vessel shall be provided with main steering gear that is:

- .1 of adequate strength and capable of steering the vessel at all service speeds;
- .2 designed to operate at maximum astern speed without being damaged or jammed; and
- .3 capable of moving the rudder from 35° on one side to 30° on the other side in not more than 28 seconds with the vessel moving ahead at maximum service speed.

10.2 Control of the main steering gear, including control of any necessary associated devices, motor, pump, valve, etc., shall be provided from the operating station.

10.3 The main steering gear shall be designed so that transfer of control from the main steering gear to the auxiliary means of steering required by regulation **IV/11** can be achieved rapidly. Any tools or equipment necessary to make the transfer shall be readily available.

10.4 The vessel's operating station shall be arranged to permit the person steering to have the best possible all around vision.

10.5 Strong and effective rudder stops shall be provided to prevent jamming and damage to the rudder and its fittings. These stops may be structural or internal to the main steering gear.

10.6 In addition to meeting the requirements of **IV/10.1** to **10.5**, a vessel with a power driven main

steering gear shall be provided with the following:

- .1 a disconnect switch located in the steering compartment, and instantaneous short circuit protection for electrical power and control circuits sized and located to the satisfaction of the Administration;
- .2 an independent rudder angle indicator at the operating station;
- .3 an arrangement that automatically resumes operation, without reset, when power is restored after a power failure;
- .4 a manual means to centre and steady the rudder(s) in an emergency; and
- .5 a limit switch to stop the steering gear before it reaches the rudder stops required by **IV/10.5**.

10.7 A vessel of more than 20 m in length with a power driven main steering gear shall in addition be provided with the following:

- .1 a visual means, located at the operating station, to indicate operation of the power units; and
- .2 instructions for transfer procedures from the main steering gear or control to the auxiliary means of steering required shall be posted at the location where the transfer is carried out.

11 Auxiliary means of steering

11.1 Except as provided in **IV/11.3**, a vessel shall be provided with an auxiliary means of steering that is:

- .1 of adequate strength;
- .2 capable of moving the rudder from 15° on one side to 15° on the other side in not more than 60 seconds with the vessel at one-half its maximum service speed ahead, or 7 knots, whichever is greater; and
- .3 controlled from a location that permits safe manoeuvring of the vessel and does not expose the person operating the auxiliary means of steering to personnel hazards during normal or heavy weather operation.

11.2 A suitable hand tiller may be used as the auxiliary means of steering.

11.3 An auxiliary means of steering need not be provided where:

- .1 the main steering gear and its controls are provided in duplicate;
- .2 multiple propeller propulsion, with independent control from the operating position, for

each screw is provided and the vessel is capable of being steered from the control station;

- .3 no regular rudder is fitted and steering action is obtained by a change of setting of the propelling unit; or
- .4 where a rudder and hand tiller are the main steering gear.

12 Propeller systems

Construction and fitting standards for propellers and associated fittings shall be to the satisfaction of the Administration. Recognised design standards shall be used.

PART C - BILGE SYSTEMS

13 General provisions for bilge systems

A vessel shall be provided with a satisfactory arrangement for draining any watertight compartment, other than small buoyancy compartments, under all practicable conditions. Sluice valves shall not be fitted in watertight bulkheads.

14 Bilge piping system

14.1 A vessel of 8 m or more in length shall be provided with individual bilge lines and bilge suction for each watertight compartment, except that the space forward of the collision bulkhead need not be fitted with a bilge suction line when the arrangement of the vessel is such that ordinary leakage may be removed from this compartment by the use of a hand portable bilge pump or other equipment, and such equipment is provided.

14.2 A bilge pipe in a vessel of less than 20 m in length shall be not less than 25 mm nominal pipe size. A bilge pipe in a vessel of 20 m or more in length shall be not less than 40 mm nominal pipe size. A bilge suction shall be fitted with a suitable strainer having an open area not less than three times the area of the bilge pipe. Strainers shall be easily accessible so that they may be cleared of dirt/debris. Alternatively a mud box may be acceptable situated above the suction pipe, provided that the strainer inside it is accessible for cleaning/clearing.

14.3 Except when individual pumps are provided for separate spaces, individual bilge suction lines shall be led to a central control point or manifold and provided with a stop valve at the control point or manifold and a non-return valve at some accessible point in the bilge line. A stop non-return valve located at a control point or manifold will meet the requirements for both a stop valve and a non-return valve.

14.4 A bilge pipe piercing the collision bulkhead shall be fitted with a screw-down valve located on the forward side of the collision bulkhead and operate from the weather deck, or, where it is readily accessible under service conditions, a screw-down valve without remote operation may be fitted to the bilge line on the after side of the collision bulkhead.

15 Bilge pumps

15.1 A vessel shall be provided with bilge pumps in accordance with **Table IV/15.1**. A second power pump is an acceptable alternative to a hand pump where it is supplied by a source of power independent of the fixed power bilge pump. Individual power pumps used for separate spaces are to be controlled from a central control point and shall have a light or other visual means at the control point to indicate operation.

TABLE IV/15.1

Number of passengers	Length of vessel	Bilge Pumps required	Min. capacity required per pump
			litres/minute
Any number	20 m or more	2 fixed power pumps	208*
50 or more passengers	Less than 20 m	1 fixed power pump; and 1 portable hand pump	95 38
Less than 50 passengers	8 m and over and less than 20 m	1 fixed power pump and 1 portable hand pump; or	38 19
		1 fixed hand pump and 1 portable hand pump;	38 19
	Less than 8 m	1 portable hand pump	19

* 190 for existing vessels

15.2 A portable hand bilge pump shall be:

- .1** capable of pumping water, but not necessarily simultaneously, from all watertight compartments; and
- .2** provided with suitable suction and discharge hoses capable of reaching the bilges for each watertight compartment.

15.3 Each fixed power bilge pump shall be self-priming. It may be driven off the main engine or other source of power. It shall be permanently connected to the bilge manifold and may also be connected to the fire main. A power bilge pump may also serve as a fire pump provided it meets the requirements of regulation **V/7**.

15.4 Where two fixed power bilge pumps are installed, they shall be driven by different sources of power. Where one pump is driven off the main engine in a single propulsion engine installation, the other shall be independently driven. In a twin propulsion engine installation, each pump may be driven off a different propulsion engine.

15.5 A submersible electric bilge pump may be used as a power bilge pump required by **Table IV/15.1** only on a vessel of less than 20 m in length carrying less than 50 passengers, other than a ferry, provided that:

- .1** the pump is listed by Underwriters' Laboratories Inc. or another independent laboratory;
- .2** the pump is used to pump out not more than one watertight compartment;
- .3** the pump is permanently mounted;
- .4** the pump is equipped with a strainer that can be readily inspected and cleaned without removal of the pump;
- .5** the pump discharge line is suitably supported;
- .6** the opening in the hull for the pump discharge shall be placed so that it is above the waterline when the vessel is heeled and trimmed to 15° and 7.5° respectively;
- .7** a positive shutoff valve is installed at the hull penetration; and
- .8** the capacity of the electrical system, including wiring, and size and number of batteries, is designed to allow all bilge pumps to be operated simultaneously.

15.6 A flexible tube or hose may be used instead of fixed pipe for the discharge line of a submersible electric bilge pump provided the hose or tube does not penetrate any required watertight bulkheads. It shall be of good quality and of substantial construction, suitable for the intended use; and highly resistant to salt water, petroleum oil, heat, and vibration, and shall be located so as to minimize the risk of accidental damage.

15.7 Where a fixed hand pump is used to comply with **Table IV/15.1**, it shall be permanently connected to the bilge system.

15.8 On a vessel of less than 20 m in length, a power driven fire pump required by regulation **V/7** may serve as a fixed power bilge pump required by regulation **IV/15.1**, provided it has the minimum flow rate required by **Table IV/15.1**.

15.9 On a vessel of 20 m or more in length, a power driven fire pump required by regulation **V/7** may serve as one of the two fixed power bilge pumps required by regulation **IV/15.1**, provided it has the minimum flow rate required by **Table IV/15.1**.

15.10 Where the bilge and fire pump systems are interconnected, the dedicated bilge pump is to be capable of pumping the bilges overboard at the same time as the fire/bilge pump charges the firemain. Stop valves and check valves shall be installed in the piping to isolate the systems during simultaneous operation and prevent possible flooding through the bilge system.

15.11 A catamaran vessel shall be equipped with bilge pumps for each hull, as if each hull is a separate vessel, in accordance with **Table IV/15.1**, except where:

- .1 one dedicated pump is located in each hull;
- .2 each dedicated pump is driven by an independent source of power;
- .3 the bilge pumping system is permanently cross-connected between hulls to facilitate pumping of either hull by either bilge pump; and
- .4 isolating valves shall be fitted within the cross connection to prevent flooding from one hull to another.

16 Bilge high level alarms

16.1 On a vessel 8 m or more in length overall, a visual and audible alarm shall be provided at the operating station to indicate a high water level in each of the following normally unmanned spaces:

- .1 a space with a through-hull fitting below the deepest load waterline, such as a lazarette;
- .2 a machinery space bilge, bilge well, shaft alley bilge, or other spaces subject to flooding from sea water piping within the space; and
- .3 a space with a non-watertight closure, such as a space with a non-watertight hatch on the main deck.

16.2 Vessels constructed of wood shall, in addition to **IV/16.1**, provide bilge level alarms in all watertight compartments except buoyancy chambers of less than 0.25 m³.

16.3 Automatic bilge pumps shall not be fitted to spaces which may contain pollutants. A visual indicator shall be provided at the operating station to indicate when any automatic bilge pump is operating.

PART D - ELECTRICAL ARRANGEMENTS

17 General provisions

17.1 The requirements for the design, construction, installation and operation of electrical equipment and systems including power sources, lighting, motors, miscellaneous equipment and safety systems shall be in accordance with accepted standards or to the satisfaction of the Administration.

17.2 Electrical equipment on a vessel shall be installed and maintained to:

- .1 provide services necessary for safety under normal and emergency conditions;
- .2 protect passengers, seafarers, other persons, and the vessel from electrical hazards,

including fire, caused by or originating in electrical equipment, and electrical shock;

- .3 minimize accidental personnel contact with energized parts; and
- .4 prevent electrical ignition of flammable vapours.

17.3 Electrical equipment used in the following locations shall be drip-proof:

- .1 a machinery space;
- .2 a location normally exposed to splashing, water washdown, or other wet conditions within a galley, a laundry, or a public washroom or toilet room that has a bath or shower; or
- .3 another space with a similar moisture level.

17.4 Electrical equipment exposed to the weather shall be watertight.

17.5 Electrical equipment exposed to corrosive environments shall be demonstrated to be of suitable construction and corrosion-resistant.

17.6 Electrical equipment and installation shall be designed and installed so that it is not affected by vessel motions or vibration of the vessel whilst underway.

17.7 All equipment, including switches, fuses, lampholders, etc., shall be rated for the voltage and current utilized.

17.8 Receptacle outlets of the type providing a grounded pole or a specific direct current polarity shall be of a configuration that will not permit improper connection.

17.9 All electrical equipment and circuits shall be clearly marked and identified.

17.10 Any cabinet, panel, box or other enclosure containing more than one source of power shall be fitted with a sign warning persons of this condition and identifying the individual circuits.

18 Power sources

18.1 Each vessel that relies on electricity to power the following loads shall be arranged so that the loads can be energized from two sources of electricity:

- .1 fuel system;
- .2 fire main;
- .3 fixed firefighting systems;
- .4 bilge system;

- .5** steering system;
- .6** propulsion system and its necessary auxiliaries and controls;
- .7** vessel's service and emergency electrical generation system and its necessary auxiliaries;
- .8** a system identified by the Administration as being crucial to the survival of the vessel or to the protection of the personnel on board;
- .9** interior lighting except for decorative lights;
- 10** communication systems including a public address system required under regulation **VII/6**;
- .11** navigation equipment and lights; and
- .12** illumination of the survival craft launching and embarkation areas and man overboard rescue equipment and rescue areas.

18.2 A vessel with batteries of adequate capacity to supply the loads specified in **IV/18.1** for three hours, or a generator or alternator driven by a propulsion engine, complies with the requirement of **IV/17.1**.

18.3 Where a vessel service generator driven by a propulsion engine is used as a source of electrical power, a vessel speed change, throttle movement or change in direction of the propeller shaft rotation shall not interrupt power to any of the loads specified in **IV/18.1**.

18.4 Each generator and motor shall be:

- .1** in a location that is accessible, adequately ventilated, and as dry as practicable; and
- .2** mounted above the bilges to avoid damage by splash and to avoid contact with low-lying vapours.

18.5 A voltmeter and an ammeter shall be provided for a generator rated at 50 volts or more. For each alternating current generator, a means for measuring frequency shall also be provided.

18.6 Each generator shall be protected by an overcurrent device with set value not exceeding 115% of the generator full load rating.

18.7 A dual voltage generator installed on a vessel shall be of the grounded type, where:

- .1** the neutral of a dual voltage system shall be solidly connected at the switchboard's neutral bus; and
- .2** the neutral bus shall be connected to ground.

19 Electrical systems

19.1 Electrical systems shall be two wire.

19.2 A system in which there is no intentional connection of the circuit to earth (an insulated system) shall be provided with double pole switches, except that single pole switches may be used in the final sub-circuit.

19.3 Single pole switches are accepted in a system with one pole earthed. Fuses shall not be installed in an earthed conductor.

19.4 The insulation resistance, using a low voltage instrument so as not to cause damage, shall not be less than 0.3 M Ω for all new vessels, but a minimum of 0.1 M Ω can be accepted on existing vessels.

19.5 All circuits, except the main supply from the battery to the starter motor and electrically driven steering motors, shall be provided with electrical protection against overload and short circuit, i.e. fuses or circuit breakers shall be installed. Short circuit protection shall be for more than twice the total rated current of the loads in the circuit protected.

19.6 Steering motors shall have an overload alarm in lieu of overload protection.

20 Cables and wiring

20.1 Electrical cables shall be constructed and fitted to a recognised standard for marine use.

20.2 Cables which are not provided with electrical protection shall be kept as short as possible and shall be "*short circuit proofed*" e.g. single core with additional insulated sleeve over the insulation of each core. Single core marine cable, which has conductor insulation and a sheath will meet this requirement without an additional sleeve.

20.3 All wiring shall be carried out with flame retardant cable. When selecting cables for relevant applications, particular attention shall be given to environmental factors such as temperature and contact with damaging substances e.g. oils and chemicals.

20.4 Adequate provision shall be made for securing electrical connections, e.g. by use of locking washers.

20.5 Electrical cables shall be installed with due regard to minimizing physical damage and the effect of moisture.

21 Batteries

21.1 Where provisions are made for charging batteries, there shall be natural or induced ventilation sufficient to dissipate the gases generated.

21.2 Each battery shall be located as high above the bilge as practicable, secured to protect against shifting with the roll and pitch of the vessel, and free from exposure to water splash or spray.

21.3 Connections shall be made to battery terminals with permanent type connectors. Spring clips or other temporary clamps are prohibited.

21.4 A battery cut-out switch which acts as an isolator shall be provided for all systems. Where a battery change-over switch is fitted and is provided with an “off” position, this may serve as the cut-out switch also.

21.5 Batteries shall be mounted in trays lined with or constructed of a material that is resistant to damage by the electrolyte.

21.6 Battery chargers shall have an ammeter connected in the charging circuit.

21.7 Batteries used for engine starting shall be located as close as possible to the engine or engines served.

22 Battery installation

22.1 Each battery installation connected to a battery charger having an output of more than 2 kW shall be located in a room, locker or enclosed box solely dedicated to the storage of batteries with adequate ventilation.

22.2 Each battery installation connected to a battery charger having an output of 2 kW or less, shall be located in a well-ventilated space and protected from falling objects and shall not be in a closet, storeroom or similar space.

23 General grounding requirements

23.1 A vessel’s hull shall not carry current as a conductor except for the following systems:

- .1** impressed current cathodic protection systems; or
- .2** battery systems for engine starting.

23.2 Receptacle outlets and attachment plugs for portable lamps, tools, and similar apparatus operating at 100 volts or more, shall have a grounding pole and a grounding conductor in the portable cord.

23.3 Each nonmetallic mast and top mast shall have a lighting ground conductor.

24 Lighting

24.1 A single hazardous event shall not be capable of disabling all lighting systems.

24.2 Lighting circuits shall be distributed through the spaces so that a total blackout cannot occur due to the failure of a single protective device.

24.3 Where general lighting is provided by a single centralised source, an alternative source of lighting shall also be provided sufficient to enable persons to make their way to the open deck or to permit work on essential machinery.

25 Hazardous Spaces

25.1 Where practicable, electrical equipment shall not be installed in a space where petroleum vapour or other hydrocarbon gas may accumulate. When equipment is installed in such a space it shall comply with a recognised standard for prevention of ignition of flammable atmosphere.

25.2 Any compartment which contains a gas consuming appliance or any compartment into which flammable gas may leak or accumulate, shall be provided with a hydrocarbon gas detector and alarm. The detector and alarm shall be designed to comply with a recognised standard for prevention of ignition of flammable atmosphere.

CHAPTER V FIRE PROTECTION

PART A - GENERAL PROVISIONS

1 Fire protection provisions

1.1 Machinery and fuel tank spaces shall be separated from accommodation spaces by boundaries, which prevent the passage of vapours.

1.2 Paint and flammable liquid lockers shall be constructed of steel or equivalent material.

1.3 Vapour barriers shall be provided in spaces where flammable and combustible liquids or vapours are present.

1.4 Survival craft shall be protected from fire hazards. Where a survival craft, and/or its boarding position, are located in a position relative to a machinery space or galley boundary, such that a fire in that space would affect either the survival craft or the ability to board it, the boundary shall be insulated to at least an A-15 structural fire protection standard.

2 Machinery space - construction

2.1 Steel Construction: Vessels which have the machinery space boundaries constructed of steel, require no additional fire protection except as described in **V/1.4**. However, the surfaces of machinery space bulkheads that are outside of the machinery space shall be coated only with finishes which meet the requirements for low flame spread when tested in accordance with Resolution A.653(16) of the International Maritime Organization.

2.2 Fibre Reinforced Plastic (FRP) Construction: Machinery space boundaries should prevent the passage of smoke and flame for 15 minutes, when tested in accordance with the procedure shown in **Annex 4**. Fire resistance of FRP may be achieved by the use of woven roving glass layers or additives to the resin, or by insulation. Intumescent polyester resin surface coatings may also be used; however, solvent-borne intumescent paints shall not be used. The Administration may waive the requirement for the test described in **Annex 4** where the construction complies with an ISO or equivalent standard to give at least the same level of protection.

2.3 Aluminium and Wood Construction: Machinery space boundaries shall have an equivalent level of fire protection when compared with FRP construction as required in regulation **V/2.2**.

2.4 Machinery space boundaries shall be as gastight as practicable so that in the event of a fire the fire extinguishing medium released or injected can be retained for sufficient time to extinguish the fire.

2.5 Where it is not practical to have a machinery space, the engine shall be enclosed in a box. The box shall perform the same function as the machinery space boundaries in regulation **V/2.4**.

2.6 Portlights or windows shall not be fitted in the boundary of the machinery space, except that an observation port having a maximum diameter of 150 mm may be fitted, provided the frame is

constructed of steel or brass and the port is fitted with a permanently attached steel or brass cover with securing arrangements.

3 Insulation

3.1 Insulating materials fitted in the machinery space of new vessels shall be non-combustible when tested in accordance with Resolution A.799(19)⁷ of the International Maritime Organization. Insulating materials fitted in the engine space of existing vessels shall not be readily ignitable. Insulation shall be covered with a material impervious to oil or oil vapour.

3.2 Any insulation composite may be considered not readily ignitable where the test defined in **Annex 5** is carried out on a representative specimen and the result is satisfactory. In such testing, the specimen edge need not be tested where the insulation is fitted without exposed edges and specimen conditioning may be curtailed as appropriate to the material under test.

4 Cooking appliances

4.1 Fire protection arrangements in cooking spaces shall be in accordance with the following:

- .1** in the case of a cooking area that is common with any part of the accommodation, the area surrounding the cooking appliances shall be protected by fire retardant sheathing or similar to a distance of 2 m on all bulkheads and deckheads adjacent to the cooking appliances;
- .2** cooking appliances such as deep-fat fryers or other appliances presenting a high fire hazard are not permitted unless they are situated in a separate enclosed compartment capable of being closed off against the rest of the accommodation and the compartment is fitted with a fixed fire extinguishing system;
- .3** suitable fire retardant barriers shall be built around the cooking and heating appliances where they are adjacent to combustible materials and structures;
- .4** cooking range exhaust hoods and ducts shall be fitted with a grease trap; and
- .5** combustible materials not needed in the cooking area shall be stored away from the area.

Materials which are in the vicinity of an open flame cooking appliance shall be non-combustible, except that these materials may be faced with any surface finish which meet the requirements for low flame spread when tested in accordance with Resolution A.653(16)⁸ of the International Maritime Organization.

⁷ IMO Resolution A.799(19) as amended by MSC Resolution MSC.101(73) - Amendments to the International Code for Application of Fire Test Procedures (FTP Code).

⁸IMO Resolution A.653(16) as amended by MSC Resolution MSC.101(73) - Amendments to the International Code for Application of Fire Test Procedures (FTP Code).

4.2 Combustible materials and other surfaces which do not meet the requirements for low flame spread shall not be left unprotected within the following distances of the cooker:

- .1** 600 mm vertically above the cooker, for horizontal surfaces;
- .2** 600 mm horizontally from the cooker, for vertical surfaces.

4.3 Curtains shall not be fitted within 900 mm of an open flame cooking appliance.

4.4 Cooking appliances which are fuelled by compressed gas shall have a gas shut off valve adjacent to the cooking appliance and a second shut off valve at the gas cylinder.

5 Fire safety

5.1 When spare gasoline is carried on board in portable containers for any purpose, the containers shall be clearly marked and shall be stowed on the weather deck where they can be readily jettisoned and where spillage will drain directly overboard. Except as approved by the Administration a portable container shall not exceed 27 litres and the quantity of gasoline and number of containers shall be kept to a minimum.

5.2 Combustible materials not required for the operation and maintenance of machinery, shall not be stowed in the machinery space. Any materials stowed in the machinery space shall be properly secured and cause no obstruction to access in or from the space.

5.3 Gas welding and cutting equipment, where carried, shall be stowed in secure manner on the open deck at a safe distance away from any potential source of fire and shall have the capability of being readily jettisoned overboard where necessary.

5.4 Machinery containing oil shall be provided with a readily accessible galvanised steel drip tray or other suitable means to collect and retain leakages containing oil. The machinery space shall be kept clean and tidy. Oily water shall be collected and properly disposed of ashore.

5.5 Fire hazards shall be minimised in so far as it is reasonable and practicable and combustible materials shall be insulated from heated surfaces such as exhaust pipes and manifolds.

5.6 Savealls or equivalent means of containment of spillage shall be provided below fuel pumps and filters.

PART B - FIRE EXTINGUISHING AND DETECTING EQUIPMENT

6 Equipment installed but not required

Fire extinguishing and detecting equipment installed on a vessel in excess of the requirements shall be designed, constructed, installed and maintained in accordance with a recognised industry standard acceptable to the Administration.

7 Fire pumps

7.1 On all vessels of 15 m or more in length a self priming, power driven fire pump or hand pump shall be installed. A power driven pump shall be capable of projecting a jet of water at least 7.5 m from the nozzle of a hose attached to any hydrant in the system with one hydrant open. A hand pump shall be capable of delivering one jet of water to any part of the ship through a hose and nozzle.

7.2 On new vessels of 15 m or more in length at least one self priming, power driven fire pump is required which shall have a minimum capacity 15 m³/hr.

7.3 A fire pump may be driven by a propulsion engine where the propeller shaft can be readily disengaged or a controllable pitch propeller is fitted. A fire pump shall be permanently connected to the fire main where fitted and may be connected to the bilge system.

7.4 Where the fire pump is located in the machinery space, it shall be capable of both remote operation from the operating station and local, manual operation at the pump.

7.5 Fire pumps fitted to new vessels certified to operate in exposed waters shall have two independent sources of power or equivalent arrangements.

8 Fire main and hydrants

A vessel that has a power driven fire pump shall have a sufficient number of fire hydrants to allow a fire in any part of the vessel to be reached using a single length of fire hose.

9 Fire hoses and nozzles

9.1 A fire hose with a nozzle shall be attached to each fire hydrant at all times or stowed immediately adjacent to the hydrant together with relevant fittings and tools, ready for immediate connection and use.

9.2 On a vessel of less than 20 m in length, carrying 50 or more passengers, and on a vessel of 20 m in length or over, each hose shall be to recognized standards and be not less than 7.5 m or more than 15 m in length and 40 mm in diameter. It shall have fittings of brass or other approved material that can connect with each hydrant or with other length of fire hose.

9.3 Each fire hose on a vessel of less than 20 m in length carrying less than 50 passengers shall be approved by the Administration and be of one piece not less than 7.5 m and not more than 15 m in length. It shall have fittings of brass or other approved material that can connect to any hydrant or to any other length of fire hose.

9.4 Each nozzle shall be of corrosion-resistant material and be capable of being changed between a solid stream and a spray pattern. A nozzle on a vessel of less than 20 m in length carrying 50 or more passengers, and on a vessel of 20 m or more in length, shall be of a type approved by the Administration.

10 Requirement for fixed fire extinguishing and detecting systems

10.1 Subject to **V/10.2**, the following spaces shall be equipped with a fixed gas or other fixed fire extinguishing system in accordance with the provisions of the FSS Code if deemed appropriate and approved by the Administration:

- .1** a space containing an internal combustion engine of more than 37 kW;
- .2** a space containing an oil fired boiler;
- .3** a space containing machinery powered by gasoline or other fuels having a flash point of 43°C or lower;
- .4** a space containing a fuel tank for gasoline or any other fuel having a flash point of 43°C or lower;
- .5** a paint locker; and
- .6** a storeroom or cargo space containing flammable liquids, including liquors of 80° proof or higher where liquor is packaged in individual containers of 9.5 litres capacity or greater.

10.2 A fixed fire extinguishing system in accordance with regulation **V/10.1** is not required in a space where:

- .1** the space is open to the atmosphere and the Administration determines that a fixed gas fire extinguishing system would be ineffective; or
- .2** the amount of carbon dioxide gas required in a fixed fire extinguishing system can be supplied by one portable extinguisher or a semi-portable extinguisher meeting the following requirements:
 - .1** cylinders shall be installed in a fixed position outside the space protected;
 - .2** the applicator shall be installed in a fixed position so as to discharge into the space protected; and
 - .3** controls shall be installed in an accessible location outside the space protected.

10.3 Except where the space is manned, the following spaces shall be equipped with a fire detecting system of an approved type that is installed to the satisfaction of the Administration and in accordance with the provisions of the FSS Code if deemed appropriate:

- .1** a space containing propulsion machinery;
- .2** a space containing an internal combustion engine of more than 37 kW;

- .3 a space containing an oil fired boiler;
- .4 a space containing machinery powered by gasoline or any other fuels having a flash point of 43°C or lower;
- .5 a space containing a fuel tank for gasoline or any other fuel having a flash point of 43°C or lower; and
- .6 each overnight accommodation space on a vessel with overnight accommodation for passengers.

10.4 When a fixed fire extinguishing system, which is not a portable extinguisher, is installed in a machinery space, it shall be of a type approved by the Administration or equivalent and in accordance with the provisions of the FSS Code if deemed appropriate. The type of system shall be appropriate to the space being protected.

Such fixed installation systems in machinery spaces include:

- .1 low expansion foam;
- .2 medium expansion foam;
- .3 high expansion foam;
- .4 carbon dioxide;
- .5 pressure water spraying; and
- .6 vapourising fluids.

10.5 All grills, broilers, and deep fat fryers shall be fitted with a grease extraction hood to the satisfaction of the Administration.

10.6 A fixed gas fire extinguishing system may protect more than one space. The quantity of extinguishing agent shall be at least sufficient for the space requiring the greatest quantity.

11 Number, type and location of portable fire extinguishers

11.1 Each portable fire extinguisher on a vessel shall be of an approved type. The minimum number and type of portable fire extinguishers required on a vessel shall be acceptable to the Administration, and shall be not less than the minimum number required by **Table V/11** and other provisions of this regulation.

TABLE V/11

Space protected	Minimum No. required	Type extinguisher permitted		
		Class	Medium	Minimum size
Operating Station	1	B-I, C-I	CO ₂	1.8 kg
			Dry Chemical	0.9 kg
Machinery Space	1	B-II, C-II located just outside exit.	CO ₂	6.8 kg
Accommodation Spaces	1 for each 230 m ² or part thereof	A-II	Foam	9.5 l
			Dry Chemical	4.5 kg
Galley, Pantry, Concession Stand	1	A-II, B-II	Foam	9.5 l
			Dry Chemical	4.5 kg
			CO ₂	6.8 kg

11.2 The installation and location of the portable extinguishers shall be to the satisfaction of the Administration and in accordance with resolution A.951(23) and the Fire Safety Systems code where deemed appropriate.

12 Fire axe

A vessel of 20 m or more in length shall have at least one fire axe located in or adjacent to the primary operating station.

13 Fire bucket

All vessels which are not required to have a fire pump, either manual or power driven, shall carry at least two fire buckets of at least 9 litres capacity each, with an attached lanyard capable of allowing them to be filled from the sea and recovered, placed so as to be easily available during an emergency. The fire buckets shall have strongly attached handles capable of recovering a fully laden bucket from the sea and the words "FIRE BUCKET" shall be marked in a contrasting colour on each bucket. The fire buckets shall be used for no other purposes.

14 Servicing of fixed and portable fire extinguishers

Fixed and portable fire extinguishers shall be serviced annually and the date of service recorded on a tag or label affixed to the extinguisher.

15 Fire blanket

All ships which have a galley or cooking area shall be provided with a fire blanket which is positioned such that is available for immediate use in the event of a fire in the galley or cooking area.

**CHAPTER VI
LIFESAVING EQUIPMENT****1 General provisions**

1.1 Each item of lifesaving equipment carried on board a vessel whether required to be carried or not, shall comply with the technical specifications of the LSA Code, or be approved to an appropriate standard by the Administration.

1.2 Each item of lifesaving equipment carried on board a vessel shall be maintained in accordance with manufacturer's instructions and be ready for immediate use.

2 Number and type of survival craft

2.1 Vessels certified to operate in exposed waters shall carry lifeboats or liferafts sufficient to accommodate the total number of persons on board.

2.2 New vessels certified to operate in exposed waters shall carry a man-overboard boat or rescue boat which may be one of the lifeboats provided in **VI/2.1** or alternative arrangement to bring a person horizontally on board from the water within 15 minutes.

2.3 Vessels operating solely within coastal waters and protected waters shall carry lifeboats and/or liferafts, and/or buoyant apparatus, sufficient in aggregate to accommodate the total number of persons on board. If liferafts are fitted they may be of the open reversible type.

2.4 Where the life-saving appliances and their launching appliances, where applicable, are not accessible from both sides of the vessel, additional life-saving appliances shall be fitted as required by the Administration.

2.5 The means and arrangements for embarkation into the survival craft shall be adequate, clearly marked and illuminated and approved by the Administration.

2.6 The manufacturer's model identification, the number given by the approving Administration and number of survivors for which the apparatus was approved shall be recorded on a tag or label and affixed to the apparatus.

3 EPIRB, SART and radar reflector

3.1 Each vessel certified to operate in exposed waters, shall carry:

- .1** a 406 MHz Emergency Position Indicating Radio Beacon (EPIRB), installed to automatically float free and activate; and
- .2** a 9 GHz Search and Rescue Radar Transponder (SART) so stowed that can be easily utilized.

3.2 The EPIRB required by **VI/3.1** must be:

- .1** installed in an easily accessible position;
- .2** ready to be manually released and capable of being carried by one person into a survival craft;
- .3** capable of floating free if the ship sinks and of being automatically activated when afloat;
- .4** capable of being activated manually; and
- .5** registered with the appropriate authority.

3.3 Where practicable, as determined by the Administration, all vessels shall be provided with an efficient radar reflector.

4 Distress signals

4.1 All vessels to which the Code applies shall carry:

- .1** six hand held red flare signals;
- .2** two buoyant orange smoke signals; and
- .3** six rocket parachute flares.

Provided that vessels operating solely in protected areas may carry six hand-held red flare signals, two buoyant orange smoke signals and two rocket parachute flares.

4.2 Distress pyrotechnics shall be stowed in a portable watertight container carried at the operating station.

4.3 Each distress signal shall be clearly marked with the date of manufacture and the date of expiry.

5 Lifebuoys

5.1 A vessel of less than 10 m in length overall shall carry a minimum of one ring lifebuoy.

5.2 A vessel of 10 m or more in length overall, but not more than 20 m length overall, shall carry a minimum of two ring lifebuoys.

5.3 A vessel of more than 20 m in length overall shall carry a minimum of three ring lifebuoys.

5.4 Each ring life buoy on a vessel shall:

- .1** be readily accessible;
- .2** be stowed in a way that it can be rapidly cast loose;
- .3** not be permanently secured in any way;
- .4** be orange in colour;
- .5** be marked with the vessels name, identification number and port of registry where applicable; and

5.5 At least one of the ring life buoys required by **VI/5.1**, **VI/5.2** or **VI/5.3** shall be fitted with a lifeline. Where more than one ring life buoy is carried one shall not have a lifeline attached.

5.6 For vessels operating between the hours of sunset and sunrise, a self igniting lifebuoy light shall be attached to one of the buoys required by **VI/5.1**, **VI/5.2** or **VI/5.3**.

5.7 Each lifeline on a ring life buoy shall:

- .1** be buoyant;
- .2** be of at least 18.5 m in length;
- .3** be non-kinking;
- .4** have a diameter of at least 8 mm;
- .5** have a breaking strength of at least 5 kN; and
- .6** be of a dark colour where synthetic, or of a type certified to be resistant to deterioration from ultraviolet light.

6 Lifejackets

6.1 A number of adult sized life jackets shall be provided equivalent to the maximum number of persons permitted to be carried in a vessel. If the adult lifejackets on board are not designed to fit persons weighing up to 140 kg and with a chest girth up to 1,750 mm, a sufficient number of suitable accessories shall be available on board to allow them to be secured to such persons.

6.2 A number of child size life jackets shall be carried equal to at least 10% of the total number of persons carried or such greater number as may be required to provide a lifejacket for each child. In addition, a number of infant size life jackets shall be carried equal to at least 2.5% of the total number of persons carried or such greater number as may be required to provide a lifejacket for each infant. Children's and infants lifejackets need not be carried where the vessel's SCV Safety Certificate is endorsed "*for the carriage of adults only*".

6.3 Each life jacket carried shall have a life jacket light and a whistle firmly secured by a cord. Each life jacket light shall be securely attached to the front shoulder area of the life jacket.

6.4 Unless otherwise stated in this Chapter, lifejackets shall be stored in convenient places, marked to the satisfaction of the Administration, distributed throughout accommodation spaces.

6.5 Lifejackets on vessels operating in coastal and exposed waters shall comply with the LSA Code. On vessels operating in protected waters they shall have a minimum buoyancy of 100N but other suitable standards can be accepted as determined by the Administration.

7 Stowage of survival craft

7.1 Each survival craft shall be:

- .1** stowed in a position that is readily accessible to seafarers for launching, or else provided with a remotely operated device that releases the survival craft into launching position or into the water;
- .2** stowed in a way that permits manual release from its securing arrangements;
- .3** ready for immediate use so that seafarers can carry out preparations for embarkation and launching in less than 5 minutes;
- .4** provided with means to prevent inadvertent movement of the survival craft in relation to its stowage arrangements;
- .5** stowed in a way that neither the survival craft nor its stowage arrangements will interfere with the embarkation and operation of any other survival craft at any other launching station;
- .6** stowed in a way that any protective covers will not interfere with launching and embarkation; and
- .7** stowed, as far as practicable, in a position sheltered from breaking seas and protected from damage by fire.

7.2 In addition to the requirements of **VI/7.1**, liferafts shall be secured to the vessel by a painter system with a float-free arrangement which complies with the requirements of the LSA Code.

7.3 In addition to the requirements of regulation **VI/7.1**, buoyant apparatus shall comply with the following:

- .1** each buoyant apparatus shall be attached permanently to the vessel by a painter and float free unit. The weak link used in the float free unit shall have a breaking strain, which is less than that of the painter;

- .2 the means used to attach the float-free link to the vessel shall:
 - .1 have a breaking strength of at least the breaking strength of the painter; and
 - .2 where synthetic, be of a dark colour or of a type certified to be resistant to deterioration from ultraviolet light; and
 - .3 where metal, be corrosion resistant.

7.4 A mechanical, manually operated device to assist in launching a survival craft shall be provided where the survival craft weighs more than 90 kg.

8 Special provisions for buoyant apparatus

8.1 Buoyant apparatus shall be of adequate capacity for the number of survivors indicated on its identification tag.

8.2 Where the buoyant apparatus does not have a painter attachment fitting, a means for attaching the painter shall be provided by a wire or line that:

- .1 encircles the body of the device;
- .2 will not slip off;
- .3 has a breaking strength that is at least the strength of the painter; and
- .4 where synthetic, is of a dark colour or is of a type certified to be resistant to deterioration from ultraviolet light.

8.3 Where the vessel carries more than one buoyant apparatus in a group, then each group shall be secured by a single painter.

8.4 The combined weight of each group of buoyant apparatus shall not exceed 180 kg.

8.5 Each buoyant apparatus shall be individually attached to the painter by a line long enough that each buoyant apparatus can float without contacting any other buoyant apparatus in the group. The strength of the float-free link and the strength of the painter shall be determined by the combined capacity of the group of buoyant apparatus.

8.6 Buoyant apparatus shall not be stowed in tiers more than 1.25 m high. When stowed in tiers, the separate units shall be kept apart by spacers.

8.7 Each buoyant apparatus shall be fitted with a lifeline, pendants, a painter and a light.

8.8 The equipment required for buoyant apparatus shall meet the following specifications:

- .1** The lifeline and pendants shall be as furnished by the manufacturer with the approved buoyant apparatus; and
- .2** The painter shall comply with the requirements of the LSA Code.

8.9 The approval standards for buoyant apparatus shall be determined by the Administration.

9 Servicing and repair of life saving appliances

9.1 Mechanical float free arrangement

All mechanical float free arrangements shall be serviced at intervals of not more than 12 months. Where the mechanical float free arrangement is a hydrostatic release unit, it shall be serviced:

- .1** at intervals not exceeding twelve months by a service station authorized to service it, however, in cases where it appears reasonable, the Administration may extend this period up to a maximum of seventeen months; and
- .2** at an approved service station which is competent to service it, maintains proper servicing facilities and uses only properly trained personnel.

Where the hydrostatic release unit is a sealed unit with a manufacturer defined service life, it need not be subject to annual service but it shall be replaced on its expiry.

9.2 Inflatable survival craft, inflatable liferafts and inflatable lifejackets

Every inflatable survival craft, inflatable liferaft and inflatable lifejacket shall be serviced:

- .1** at intervals not exceeding 12 months; however, in cases where it appears proper and reasonable, the Administration may extend this period up to a maximum of 17 months; and
- .2** at an approved service station which is competent to service them, maintains proper servicing facilities and uses only properly trained personnel.

9.3 Repair of inflatable survival craft

All repair and maintenance of inflatable survival craft shall be carried out in accordance with the manufacturer's instructions. Emergency repairs may be carried out on board the ship, however, permanent repairs should be effected at an approved servicing station.

9.4 Record of repair and servicing

The owner shall maintain a record of all servicing and repair of the lifesaving appliances as determined by the Administration. In the case of inflatable liferafts, the date of service shall be recorded on a tag or

label which shall be affixed to the liferaft.

10 Survival craft equipment

10.1 Each item of survival craft equipment shall be of good quality, and efficient for the purpose it is intended to serve. Unless otherwise specified in this Chapter, each item of equipment carried, whether required under this Chapter or not, shall be secured by lashings, stored in lockers, compartments, or brackets, or have equivalent mounting or storage arrangements that shall not:

- .1** reduce survival craft capacity;
- .2** reduce space available to the occupants;
- .3** interfere with launching, recovery, or rescue operations; or
- .4** adversely affect seaworthiness of the survival craft.

10.2 Each survival craft shall be fitted with such equipment as the Administration may require taking into account the operation area for which the vessel is certified.

11 Retro-reflective material

All survival craft, buoyant apparatus, lifebuoys and liferafts shall be marked with retro reflective material as indicated in Annex 1 of IMO Resolution A.658(16)⁹. The standard of the material used shall be to that prescribed by the Administration.

12 Rescue and retrieval of persons from the water

12.1 A rescue retrieval system approved by the Administration shall be provided for the retrieval of persons from the water in order to bring a person horizontally on board from the water within 15 minutes.

12.2 A vessel which is accepted as being able to act as its own rescue boat shall demonstrate the practical effectiveness of the retrieval arrangements provided on board by functional tests carried out under controlled safe conditions to the satisfaction of the Administration.

12.3 When a vessel is manned by the helmsman and one seafarer the demonstration required by **VI/12.2** shall include retrieval of the seafarer from the water (the seafarer can be assumed to be conscious).

⁹ IMO Resolution A.658(16) – Use and fitting of retro-reflective materials on lifesaving appliances.

CHAPTER VII MISCELLANEOUS SYSTEMS AND EQUIPMENT

1 General provisions

The Administration may require navigation, control or communication equipment, in excess of the equipment specifically required by the Code, on a vessel which is of a novel design, operates at high speeds in restricted or high traffic areas, or which operates on extended routes or in remote locations.

2 Navigation lights, shapes and sound signals

A vessel shall comply with the requirements of the Convention on the International Regulations for Preventing Collisions at Sea, 1972 (COLREG 1972).

3 Charts and nautical publications

3.1 A vessel shall carry up-to-date charts, appropriate for the intended voyage, of a large enough scale to enable safe navigation.

3.2 Other Nautical publications such as sailing directions, lists of lights, notices to mariners, tide tables and all other nautical publications to be carried, appropriate to the area of operation, include: as required and approved by the Administration, shall be carried on board and shall be adequate and up to date.

3.3 Extracts from the publications listed in **VII/3.2** for the areas to be transited may be provided instead of the complete publication.

3.4 The carriage of these publications required in **VII/3.2** may be in electronic format where appropriate arrangements are made for their access at all times.

3.5 An Electronic Chart Display and Information System (ECDIS) may be carried in lieu of charts required in **VII/3.1** provided it is fully compliant with the requirements of the Administration and all persons involved in its use are appropriately trained.

4 Navigation equipment

4.1 Compass

- .1** Except as otherwise provided in **VII/4.1.2** every vessel shall be fitted with a suitable magnetic compass designed for marine use, to be mounted at the primary operating station. The compass shall be illuminated.
- .2** A non-self propelled vessel need not be fitted with a compass.
- .3** On vessels certified for operation in exposed waters the compass shall be swung at least annually and a deviation card provided near to the compass.

- .4 Vessels operating only in protected waters may carry hand bearing type compass in lieu of the requirements of **VII/4.1.1**.

4.2 Radar

- .1 A vessel certified to operate in coastal or exposed waters which carries 50 or more passengers shall be fitted with marine radar system for surface navigation approved by the Administration, with a radar screen mounted at the operating station. The radar and its installation shall be suitable for the intended speed and operating area of the vessel.
- .2 A vessel certified to operate in protected waters need not be fitted with a radar where the Administration determines it is not necessary due to the vessel's operating area and local weather conditions.

4.3 Position fixing device

- .1 A vessel certified for operation in coastal and exposed waters shall be equipped with an electronic position fixing device to the satisfaction of the Administration, capable of providing accurate fixes for the area in which the vessel operates.

4.4 Other navigation equipment

A new vessel operating in exposed waters shall be provided with:

- .1 an echo sounder;
- .2 a device for measuring speed and distance through the water; and
- .3 a weather information retrieval system.

5 Radio and signalling equipment

5.1 All vessels shall be fitted with a marine VHF radio installation equipped with DSC. However where the vessel is operating in protected waters only and there is not a local facility for reception of DSC distress alerts and DSC calling, the Administration may permit vessel's VHF to not be fitted with DSC.

5.2 Vessels certified for operation in exposed waters shall be fitted with a long range communication system capable of meeting the functional requirements for radio systems contained in Chapter IV, Part C of SOLAS for operations in the A3 area.

5.3 A durable placard shall be posted next to all radio telephone installations with the emergency broadcast instructions and information, specific to the individual vessel. For an example of a suitable set of instructions and information see **Annex 6**.

5.4 When the electrical supply to radio equipment is from a battery, charging facilities, which are capable of recharging them to the minimum capacity requirements given in **VII/5.6** within 10 hours, or

a duplicate battery of capacity sufficient for the voyage shall be provided. The radio battery shall not be used for connection to any other service on board.

5.5 The battery electrical supply to radio equipment shall be protected against flooding or swamping as far as practicable and arranged so that radio communications are not interrupted. When the efficiency of the required protection against flooding/swamping cannot be guaranteed, in the case of batteries located below the freeboard deck, an efficiently protected battery supply to the radio equipment shall be provided above the freeboard deck.

5.6 When fully charged, the batteries shall provide at least six hours of operation to ensure effective use of the Radio installation.

5.7 Each battery shall be installed in accordance with regulation **IV/22**.

5.8 All vessels operating during the hours of darkness shall be provided with an efficient waterproof electric torch suitable for signalling.

6 Public address systems

6.1 This regulation applies to passenger vessels.

6.2 Except as noted in **VII/6.5** and **VII/6.6**, each passenger vessel shall be equipped with a public address system.

6.3 On a vessel of 20 m or more in length, the public address system shall be a fixed installation and be audible during normal operating conditions throughout the accommodation spaces and all other spaces normally manned by seafarers.

6.4 A vessel with more than one passenger deck and a vessel with overnight accommodation shall have the public address system operable from the operating station.

6.5 On a vessel of less than 20 m in length, a battery-powered bullhorn may serve as the public address system where it can be demonstrated to be audible throughout the accommodation spaces of the vessel during normal operating conditions. The bullhorn's batteries shall be continually maintained at a fully charged level by use of a battery charger or other means acceptable to the Administration.

6.6 On a vessel of less than 20 m in length carrying less than 50 passengers, a public address system is not required where the Administration is satisfied that a public announcement made from the operating station without amplification can be heard throughout the accommodation spaces of the vessel during normal operating conditions.

7 Mooring and ground tackle

7.1 A vessel shall be fitted with ground tackle in accordance with the anchors and cables requirements of **Annex 7**, stowed and ready for deployment, and mooring lines necessary for the vessel to be safely anchored or moored. The ground tackle and mooring lines provided shall be suitable for the size of vessel and waters in which it operates and be acceptable to the Administration with a minimum

of two anchors and cables available. In vessels of less than 12 m in length certified to operate only in protected waters, the Administration may permit the carriage of one anchor and cable.

7.2 The length of anchor line attached to an anchor shall be appropriate to the area of operation but generally shall be not less than 4 times the vessel length overall for each of the main and kedge anchors.

7.3 When the anchor line is of rope or wire, there shall be not less than one metre of chain for each metre of vessel length, up to 10 m, between the rope and the anchor.

7.4 When an anchor is more than 30 kg, an efficient mechanical means shall be provided for handling the anchor.

7.5 There shall be a strong securing point on the foredeck and a fairlead or roller at the stem head, which can be closed over the cable.

7.6 Mooring bollards, cleats and fairleads shall be securely installed taking into account the likely loads to which they will be exposed.

7.7 All the equipment mentioned in this section should be regularly inspected and adequately maintained to ensure its safe usage.

CHAPTER VIII OPERATIONAL REQUIREMENTS

PART A - OPERATIONAL REQUIREMENTS

1 General provisions

1.1 A vessel shall be manned, managed and operated safely in accordance with applicable legislation and in such a manner as to afford adequate precaution against hazards, which might endanger the vessel, its passengers and cargo.

2 Marine casualties

2.1 The owner, agent, master or person in charge of a vessel involved in a marine casualty shall notify the Administration as soon as it is practicable whenever the casualty occurs. A marine casualty is defined as an event, or sequence of events which has occurred directly in connection with the operation of the vessel that has resulted in any of the following:

- .1** loss of life or serious injury to a person which results in the person being unable to work for more than 72 hours commencing within seven days from the date when the injury was suffered;
- .2** loss of a person from the vessel;
- .3** loss, presumed loss or abandonment of a vessel;
- .4** material damage to the vessel, which means damage that:
 - .1** significantly affects the structural integrity, performance or operational characteristics of a vessel;
 - .2** requires major repair or replacement of a major component or components; or
 - .3** causes destruction of the vessel;
- .5** stranding or disabling of a vessel, or the involvement of a vessel in a collision;
- .6** material damage to the marine infrastructure external to a vessel that could seriously endanger the safety of the ship, another ship or an individual; or
- .7** severe damage to the environment, or the potential for severe damage to the environment, brought about by the damage of a vessel or vessels. However, a marine casualty does not include a deliberate act or omission with the intention to cause harm to the safety of a ship, an individual or the environment.

2.2 The notice required by **VIII/2.1** shall include the name and identity number of the vessel involved, the name of the vessel's owner or agent, the nature and circumstances of the casualty, the

locality in which it occurred, the nature and extent of injury to persons and the damage to property.

2.3 In addition to the notice required by **VIII/2.1**, the owner, master, agent or person in charge of the vessel shall, within 3 days, provide a report in writing to the Administration. The report shall contain the information required by **VIII/2.2** and where submitted without delay after the occurrence of the casualty, suffices as the notice required by **VIII/2.1**.

2.4 The IMO Code of the International Standards and Recommended Practices for a Safety Investigation into a Marine Casualty or Marine Incident (Casualty Investigation Code), adopted through Resolution MSC 255(84), is mandatory in accordance with SOLAS Convention, as amended. Chapter XI-1/6, therefore, it is not applicable, in principle, for small commercial vessels covered by this Code. However, it is highly recommended that its application be considered, as well as all relevant IMO instruments on this matter, by Administrations when considering and conducting a marine safety investigation.

2.5 The owner, agent, master or person in charge of a vessel involved in a marine incident is recommended to inform the Administration as soon as it practicable whenever a marine incident occurs. A marine incident is defined as an event, or sequence of events, other than a marine casualty which has occurred directly in connection with the operation of the vessel that endangered, or, if not corrected would endanger the safety of the ship its occupants or any other person or the environment. However, a marine incident does not include a deliberate act or omission with the intention to cause harm to the safety of a ship, an individual or the environment.

3 Logbook

3.1 Every vessel certified for operation on coastal and exposed waters shall have a Logbook on board. The master shall make or have made in the Logbook the following entries:

- .1** when a marine casualty occurs, a statement about the casualty and the circumstances under which it occurred, made immediately after the casualty when practicable to do so;
- .2** details of the voyage, including course and weather conditions at least every 4 hours, and drills tests required by this Chapter;
- .3** each death on board and the cause of death;
- .4** the name of each seaman who ceases to be a seafarer, except by death, with the time, place, manner and the cause why the seaman ceased to be a seafarer;
- .5** details of drills and training required by regulations **VIII/12** and **VIII/13**; and
- .6** the names of all seafarers employed on board for each voyage.

3.2 The log entry required by **VIII/3.1.5** in respect of abandon ship, man overboard and fire drills and training shall include the following information.

- .1** date of the drill and training; and
- .2** general description of the drill scenario and training topics.

4 Miscellaneous operating requirements

4.1 The master shall ensure that the vessel is navigated at all times in a safe and controlled manner. The master shall also ensure that all of the provisions of the SCV Safety Certificate are adhered to, however, the master may divert from the route prescribed in the SCV Safety Certificate or take such other steps as are deemed necessary and prudent to assist vessels in distress or for other similar emergencies.

4.2 The master shall ensure that applicable stability requirements are adhered to at all times.

4.3 The master shall ensure that steering gear, controls and communication systems are tested before every voyage commences and prior to entering harbour.

4.4 All hatches and openings in the hull of a vessel shall be kept tightly closed except when being used. All watertight doors in subdivision bulkheads shall be kept tightly closed during the navigation of the vessel except when being used for transit between compartments.

4.5 A vessel shall not take on fuel having a flashpoint of 43°C or lower, when passengers are on board.

4.6 A passenger vessel shall not carry dangerous goods except when allowed to do so under the International Maritime Dangerous Goods Code (IMDG Code).

4.7 The requirements of Chapter VII of SOLAS shall apply to the carriage of dangerous goods classified in regulation 2 of that Chapter, which are carried in vessels in packaged form or in solid form in bulk as appropriate.

4.8 The Administration may apply the requirements of **VIII/4.7** according to the service characteristics of the vessel and the risks associated with its operations, taking into account the safety of persons on board, the safety of property at sea and the protection of the marine environment from pollution.

4.9 Whenever an automatic pilot is used the master shall ensure that:

- .1** it is possible at all times to immediately establish manual control of the vessel's steering;
- .2** a competent person is ready at all times to take over steering control; and
- .3** the change over from automatic to manual steering and vice versa is made by, or under

the supervision of, the master or the officer on watch.

5 Pollution prevention equipment and procedures

5.1 Oil and all oily mixtures shall either be retained on board for subsequent discharge to reception facilities or discharged into the sea in accordance with the following provisions:

- .1** the vessel is proceeding en route; and
- .2** the vessel has in operation equipment of a design approved by the Administration that ensures that the oil content of the effluent without dilution does not exceed 15 parts per million

5.2 Garbage shall be disposed of in accordance with the following:

- .1** disposal into the sea of the following is prohibited:
 - .1** all plastics, including but not limited to synthetic ropes, synthetic fishing nets and plastic garbage bags; and
 - .2** all other garbage, including paper products, rags, glass, metal, bottles, crockery, dunnage, lining and packing materials;
- .2** disposal of food wastes is only permitted when;
 - .1** the vessel is en route;
 - .2** as far as practicable from land, but not less than 12 nautical miles from the nearest land; and
 - .3** the food waste is comminuted or ground and shall be capable of passing through a screen with openings no greater than 25 mm.
- .3** Any garbage mixed with other discharges having more stringent disposal or discharge requirements.

5.3 Garbage shall be disposed of in accordance with the Revised MARPOL Annex V MEPC.201(62). A simplified overview of the discharge provisions of the revised MARPOL Annex V which came into force on 1 January 2013 has been developed by the IMO and is given in **Annex 12** of this Code.

5.4 Every vessel over 100 GT and any ship certified to carry 15 persons or more will have to carry a Garbage Management Plan, to include written procedures for collecting, storing, processing and disposing of garbage, including the use of equipment on board.

5.5 Garbage record books are to be maintained by vessels carrying more than 15 persons when engaged on voyages of more than one hour in duration, see **Annex 12**.

5.6 Every vessel of 12 metres or more in length overall to display placards notifying passengers and seafarers of the disposal requirements of the regulation, see **Annex 12**.

5.7 Regulations **VIII/5.1** and **VIII/5.2** shall not apply to:

- .1** discharges or disposals into the sea necessary for the purpose of securing the safety of the vessel and those on board or saving life at sea; or
- .2** the discharge or escape of oil, waste or garbage into the sea resulting from damage to the vessel or its equipment provided all reasonable precautions have been taken before or after the occurrence of the damage for the purpose of preventing or minimising the discharge or escape.

5.8 A vessel certified to carry more than 15 persons with toilet facilities capable of discharging waste to the sea shall be fitted with a holding tank of suitable size to accommodate waste from the total number of persons on board for the duration of the voyage. Guidance on the size of the holding tank required is given in **Annex 9**. An International Sewage Pollution Prevention certificate shall be issued to such vessels that undertake International voyages.

5.9 When sewage is discharged in accordance with **VIII/5.8** vessels must be at more than 12 nautical miles from the nearest land and at a moderate rate of discharge when the ship is en route and proceeding at a speed not less than 4 knots¹⁰.

5.10 A sewage treatment plant which meets the operational requirements given in the Recommendation on International Effluent Standards and Guidelines for Performance Tests for Sewage Treatment Plants adopted by the Marine Environment Protection Committee of the International Maritime Organization by Resolution MEPC.2(VI) may be fitted in lieu of the holding tank required by **VIII/5.8**.

6 Packaged dangerous goods

6.1 Ship stores, which are dangerous goods but carried for use during the voyage are exempt from the requirements of this Section, but should be appropriately used and stowed.

6.2 General requirements

- .1** Dangerous goods are only to be carried on deck.
- .2** Reference should be made to the Administration for vessels wishing to carry both dangerous goods and passengers.
- .3** The packing, stowage and segregation requirements of the International Maritime Dangerous Goods (IMDG) Code should apply.

¹⁰ More details can be found in Regulation 11.1.1 of the revised Annex IV of MARPOL 73/78 and Resolution MEPC.157(55).

6.3 Scuppers and drains

The scupper and drainage arrangements are to be directed overboard with no connections to internal spaces.

6.4 Electrical equipment

Electrical equipment installed in the cargo space should be of the certified safe type for the cargo being carried or be capable of being securely isolated and be isolated during the carriage of packaged dangerous goods.

6.5 Structural fire protection

Bulkheads forming boundaries containing fuel tank and engine spaces are to be insulated to A-60 standard unless the dangerous goods are stowed 3 m away from such bulkheads and boundaries.

6.6 Fire fighting equipment

- .1 There should be an immediate availability of water from the fire main such as an engine driven fire pump and, in addition, from a manual fire pump. The two pumps will be required when carrying Class 1 dangerous goods only. Each pump shall be capable of supplying the hoses and nozzles, required in accordance with regulation V/7.
- .2 At least two portable dry powder extinguishers each rated at least at 34B¹¹ are to be provided and be readily available to the cargo area.

6.7 Seafarer training

The crew should undergo training in the carriage of dangerous goods and the IMDG Code and records kept of the training undertaken.

6.8 Vessel certification

- .1 Prior to dangerous packaged goods being carried, the vessel should be surveyed and shown to be suitable for the carriage of packaged dangerous goods.
- .2 Upon successful completion of a survey, a Document of Compliance will be issued to the vessel indicating the Class of goods that can be carried with a list of equipment fitted.

6.9 Cargo documentation

- .1 When packaged dangerous goods are carried, details of the emergency fire fighting equipment and First Aid medical procedures should be provided on board, with

¹¹ Can successfully extinguish 34 litres of burning flammable liquid under test conditions.

additional equipment if required under the IMDG Code, to ensure that if an emergency occurs, it can be dealt with effectively.

- .2 When carrying packaged dangerous goods, a full manifest of the cargo shall be retained ashore by the vessels owner, or other designated person, in case of an incident. This person ashore should have a list of contact numbers for the emergency services and relevant manufacturers/suppliers of the dangerous goods. The designated person should be made aware of the details of the voyage.

6.10 Permitted packaged dangerous goods

- .1 A restricted list of dangerous goods, as contained in the IMDG Code, will be permitted:

Class 1	Explosives - when carrying military explosives a qualified military or explosive expert should be present when explosives are being loaded, carried and unloaded;
Class 2.1	Flammable gases;
Class 2.2	Non-flammable, non-toxic gases;
Class 2.3	Toxic gases – PROHIBITED ;
Class 3	Flammable Liquids Substances the size of the container carrying will be limited to 30 litres;
Class 4	Flammable solids; substances liable to spontaneous combustion; substances which, in contact with water emit flammable gasses – PROHIBITED ;
Class 5	Oxidizing substances and organic peroxides – PROHIBITED ;
Class 6. 1	Toxic substances - packing group III substances only permitted with a limit of 30 litres and 30 kg;
Class 6.2	Infectious substances – PROHIBITED ;
Class 7	Radioactive material– PROHIBITED ;
Class 8	Corrosive Substances - packing group I and II substances PROHIBITED , packing group III substances restricted to 30 litres max; and
Class 9	Miscellaneous dangerous substances and articles subject to container capacity, 30 litres liquid, and 30 kg weight.

- .2 Although the above table restricts the carriage of certain classes of dangerous goods,

when these goods are carried in Limited or Excepted Quantities as laid down in the IMDG Code, the restrictions do not apply and the goods may be carried.

- .3 Should an operator want to carry prohibited packaged dangerous goods on a regular basis, then a submission, with a safety assessment, should be submitted to the Administration.

PART B - PREPARATIONS FOR EMERGENCIES

7 Record of passengers

7.1 The owner, charterer, managing operator or master of a vessel making a voyage in exposed or coastal waters shall keep an accurate record of all persons, which embark on and disembark from the vessel, including the names and gender, distinguishing between adults, children and infants.

7.2 The owner, charterer, managing operator or master of a vessel on any other type of voyage shall keep a correct, written count of all passengers, which embark on and disembark from the vessel. Prior to departing on a voyage, the passenger count shall be deposited ashore in a well marked location or with a representative of the owner or managing operator of the vessel.

7.3 Administrations may exempt passenger ships from the full requirements of paragraph **VIII/7.1**, if the scheduled voyages of such ships render it impracticable for them to prepare such records.

8 Passenger safety

8.1 Before getting underway on a voyage where passengers are carried, the master of a vessel shall ensure that suitable public announcements are made informing all passengers of the following, as applicable to the vessel's operations and arrangement:

- .1 a general explanation of emergency procedures;
- .2 the location of emergency exits and survival craft embarkation areas;
- .3 the stowage location of lifejackets;
- .4 the proper method of putting on and adjusting lifejackets of the type carried on the vessel including a demonstration of the proper donning of a lifejacket;
- .5 the location of the instruction placards for lifejackets and other lifesaving devices; and
- .6 that all passengers will be required to wear lifejackets when possible hazardous conditions exist, as directed by the master.

8.2 As an alternative to an announcement that complies with **VIII/8.1**, the master or another designated person may:

- .1** prior to getting underway, deliver to each passenger or, on a vessel that does not carry vehicles and that has seats for each passenger, place near each seat, a card or pamphlet that has the information listed in **VIII/8.1.1** to **VIII/8.1.6**; and
- .2** make an abbreviated announcement consisting of:
 - .1** a statement that passengers should follow the instructions of seafarers in an emergency;
 - .2** the location of lifejackets; and
 - .3** that further information concerning emergency procedures including the donning of lifejackets, location of other emergency equipment, and emergency evacuation procedures are located on the card or pamphlet that was given to each passenger or is located near each seat.

8.3 Ferries operating on short runs of less than 15 minutes may substitute bulkhead placards or signs for the announcement required in **VIII/8.1** and **VIII/8.2** where the Administration determines that the announcements are not practical due to the vessel's unique operation.

8.4 On a vessel on a voyage of more than 12 hours duration, passengers shall be requested to put on lifejackets and go to the appropriate embarkation station during the safety orientation. Where only a small number of passengers embark at a port after the original muster has been held, these passengers shall be given the passenger safety orientation required by **VIII/8.1** or **VIII/8.2** if another muster is not held.

8.5 The master of a vessel shall require passengers to wear lifejackets when possible hazardous conditions exist, including, but not limited to:

- .1** when transiting hazardous bars and inlets;
- .2** during severe weather;
- .3** in event of flooding, fire or other events which may possibly call for evacuation; and
- .4** when the vessel is being towed.

8.6 Sufficient emergency instructions shall be posted to enable passengers to know what action to take in the event of an emergency.

8.7 Sufficient instructions on how to don lifejackets shall be posted to enable passengers to undertake this action in the event of an emergency.

9 Emergency instructions

9.1 The master and seafarers of a vessel shall be familiar with the content of emergency instructions containing the actions to be taken in the event of fire, heavy weather, or man overboard conditions. Such instructions shall be displayed at the operating station.

9.2 Except when in the opinion of the Administration the operation of a vessel does not present any of the hazards listed, the emergency instruction placard shall contain at least the applicable portions of the “Emergency Instructions” listed in regulation **VIII/10**. The emergency instructions shall be designed to take account of the particular equipment, arrangement, and operation of each individual vessel.

9.3 Where the Administration determines that there is no suitable mounting surface aboard the vessel, the emergency instructions need not be posted but shall be carried aboard the vessel and be available to seafarers for familiarization.

10 Recommended emergency instructions format

An emergency instruction placard containing the following information will satisfy the requirements of regulation **VIII/9**.

EMERGENCY INSTRUCTIONS**10.1 Rough weather at sea, crossing hazardous bars or flooding**

- 1.** Close all watertight and weathertight doors, hatches, and airports to prevent taking water aboard.
- 2.** Keep bilges dry to prevent loss of stability due to water in bilges. Use power driven bilge pump, hand pump, and buckets to dewater.
- 3.** Arrange fire pumps to be used as bilge pumps where permitted.
- 4.** Check all intake and discharge lines, which penetrate the hull, for leakage.
- 5.** Passengers shall remain seated and evenly distributed as directed by the master.
- 6.** Passengers shall wear life jackets when instructed by the master.
- 7.** Where assistance is needed follow the procedures on the emergency broadcast placard posted by the radiotelephone.
- 8.** Prepare survival craft (life floats, (inflatable) rafts, (inflatable) buoyant apparatus, boats) for launching.
- 9.** Instructions to abandon the vessel shall not be given unless in the opinion of the master the risk of persons remaining on board exceeds the risk of evacuating the vessel.

10.2 Man overboard

1. Throw a life buoy overboard as close to the person as possible.
2. Post a lookout to keep the person overboard in sight.
3. Launch the rescue boat and manoeuvre to pick up person in the water, or manoeuvre the vessel to pick up the person in the water.
4. Have a seafarer put on lifejacket, attach a safety line to him or her, and have him or her stand by ready to jump into the water to assist the person overboard if necessary.
5. Where person is not immediately located, notify Coast Guard and other vessels in vicinity by radiotelephone.
6. Continue search until released by Coast Guard or where the master considers it impracticable to continue the search.

10.3 Fire

1. Cut off air supply to fire – close items such as hatches, dampers, ports, doors, ventilators, and louvers, and shut off ventilation system.
2. Cut off electrical system supplying affected compartment if possible.
3. Where safe, immediately use portable fire extinguishers at base of flames for flammable liquid or grease fires or water for fires in ordinary combustible materials. Do not use water on electrical fire.
4. Where fire is in machinery spaces, shut off fuel supply and ventilation and activate fixed extinguishing system if installed.
5. Manoeuvre vessel to minimize effect of wind on fire.
6. Where unable to control fire, immediately notify the Coast Guard and other craft in the vicinity by radiotelephone.
7. Move passengers away from fire, have them put on lifejackets, and where necessary, prepare to abandon the vessel.

11 Emergency station bill

11.1 On a vessel of more than 20 m in length required to have more than four seafarers at any one time, including the master, a station bill shall be posted by the master.

11.2 The station bill required by **VIII/11.1** shall set forth the special duties and duty station of each seafarer for various emergencies. The duties shall, as far as possible, be consistent with the regular work

of the individual. The duties shall include at least the following and any other duties necessary for the proper handling of a particular emergency:

- .1 the closing of hatches, fire dampers, watertight doors, air vents, scuppers, and valves for intake and discharge lines that penetrate the hull, the stopping of fans and ventilating systems, and the operating of all safety equipment;
- .2 the preparing and launching of survival craft and rescue boats;
- .3 the extinguishing of fire; and
- .4 the mustering of passengers including the following:
 - .1 warning the passengers;
 - .2 assembling the passengers and directing them to their appointed stations; and
 - .3 keeping order in the passageways and stairways and generally controlling the movement of the passengers.

11.3 The station bill shall be posted at the operating station and in a conspicuous location in each seafarer accommodation space.

12 Abandon ship and man overboard drills and training

12.1 The master shall conduct sufficient drills and give sufficient instructions to make sure that all seafarers are familiar with their duties during emergencies that necessitate abandoning ship or the recovery of persons who have fallen overboard.

12.2 Each abandon ship drill shall include:

- .1 summoning the seafarers to report to assigned stations and prepare for assigned duties;
- .2 summoning passengers on a vessel on an overnight voyage to muster stations or embarkation stations and ensuring that they are made aware of how the order to abandon ship will be given;
- .3 checking that lifejackets are correctly worn; and
- .4 instructions on the automatic and manual deployment of survival craft.

12.3 Each abandon ship drill shall, as far as practicable, be conducted as if there were an actual emergency.

12.4 Each rescue boat where provided, shall be launched with its assigned seafarers aboard and manoeuvred in the water as if during an actual man overboard situation:

- .1 once each month, where reasonable and practicable; but
- .2 at least once within a 3 month period before the vessel gets underway with passengers.

13 Firefighting drills and training

13.1 The master shall conduct sufficient fire drills to make sure that each seafarer is familiar with his or her duties in case of a fire.

13.2 Each fire drill shall include:

- .1 summoning seafarers to report to assigned stations and to prepare for and demonstrate assigned duties;
- .2 summoning passengers on a vessel on an overnight voyage to muster or embarkation stations; and
- .3 instruction in the use and location of fire alarms, extinguishers, and any other firefighting equipment on board.

13.3 Each fire drill shall, as far as practicable, be conducted as if there were an actual emergency.

14 Emergency situations

14.1 Nothing in the emergency instructions or a station bill required by this Chapter exempts any licensed individual from the exercise of good judgement in an emergency situation.

15 Markings required

15.1 The following marking is required:

- .1 all lifesaving and fire fighting equipment shall be marked with the vessel's identity number;
- .2 all escape hatches and other emergency exits used as means of escape shall be marked on both sides in clearly legible letters at least 50 mm: "EMERGENCY EXIT, KEEP CLEAR", unless such markings are deemed unnecessary by the Administration;
- .3 remote fuel shutoff stations shall be marked in clearly legible letters at least 25 mm high indicating purpose of the valve and direction of operation; and
- .4 watertight doors and watertight hatches shall be marked on both sides in clearly legible letters at least 25 mm high: "WATERTIGHT DOOR - KEEP CLOSED" or "WATERTIGHT HATCH - KEEP CLOSED", unless such markings are deemed

unnecessary by the Administration.

15.2 Complete but simple instructions for the operation of a fixed gas fire extinguishing system shall be located in a conspicuous place at or near each pull box and stop valve control and in the space where the extinguishing agent cylinders are stored. Emergency signs and warnings shall be to the satisfaction of the Administration.

16 Operational readiness, maintenance and inspection of lifesaving equipment

Each launching appliance and each survival craft and rescue boat on a vessel shall be in good working order and ready for immediate use before the vessel leaves port and at all times when the vessel is underway. Each deck where survival craft or rescue boats are stowed or boarded shall be kept clear of obstructions that could interfere with the boarding and launching of the survival craft or rescue boat. All lifesaving equipment shall be maintained in accordance with the manufacturer's instructions and to the satisfaction of the Administration.

17 Instruction manuals, documentation, signs/notices and language used

17.1 The owner shall ensure that instruction manuals are available for all equipment and machinery onboard the ship as required by the Administration.

17.2 All instruction manuals, signs, notices, plans and documents relating to the safety and operation of the ship and its machinery and equipment shall be in the official language of the flag State and, where applicable, the working language of the seafarers.

CHAPTER IX ACCOMODATION, WELFARE, WORKING AND LIVING CONDITIONS

PART A - ACCOMMODATION

1 General

1.1 Unless stated otherwise this part applies to vessels where initial construction or major conversion began before 1 July 2018, vessels where initial construction or major conversion began on or after 1 July 2018 shall comply with the requirements of **Annex 14**.

1.2 There shall be sufficient hand holds and grab-rails within the accommodation to allow safe movement around the accommodation when the vessel is in a seaway.

1.3 Heavy items of equipment such as batteries, cooking appliances, etc., shall be securely fastened in place to prevent movement due to severe motions of the vessel. Stowage lockers containing heavy items shall have lids or doors with secure fastening.

1.4 On new vessels every space within the accommodation area and which is accessible by either passengers or seafarers shall have a ventilation system which may be natural ventilation provided that the system is designed to enable no less than six 6 air changes per hour.

1.5 An adequate standard of accommodation for all on board shall be provided particularly in vessels intended to be at sea for more than 24 hours. In providing such accommodation, primary concern shall be directed towards ensuring the health and safety aspects of persons e.g. the ventilation, lighting, water services, galley services, access and escape arrangements.

1.6 On vessels which carry berthed persons below deck, mechanical ventilation shall be provided to accommodation spaces, which are situated completely below the level of the weather deck, excluding any coach roof. As far as practicable, such ventilation arrangements shall be designed to provide at least six changes of air per hour when the access openings to the spaces are closed and the ventilation system shall have a clearly marked emergency means of stopping from a position located outside of the space for use in case of fire.

2 Seafarer spaces

2.1 Seafarer accommodation spaces and work spaces shall be of sufficient size, adequate construction, and with suitable equipment to provide for the safe operation of the vessel and the protection and accommodation of the seafarer in a manner practicable for the size, facilities, service, route, speed and modes of operation of the vessel. The deck above a seafarer accommodation space shall be located above the deepest load waterline.

2.2 Sleeping accommodation shall be provided for all seafarers on board the vessel where it is operated for more than 12 hours in a 24-hour period, unless the seafarers are put ashore and the vessel is provided with relief seafarers.

2.3 Sleeping accommodation shall consist of a bunk or cot for each seafarer and at least 50% of these shall be provided with lee boards or lee cloths.

3 Water services

3.1 An adequate supply of drinking water shall be provided and piped to convenient positions throughout the accommodation spaces if appropriate.

3.2 The total quantity of drinking water carried shall equate to a minimum of 4 litres per person per day (24 hours) on board.

3.3 In addition, an emergency (dedicated reserve) supply of drinking water shall be carried at the rate of 10% of the total in **IX/3.2**.

4 Galley

4.1 A galley shall be fitted with a means for cooking and means for washing food and utensils, and have adequate working surfaces for the preparation of food. The floor shall have a non-slip surface.

4.2 When a cooking appliance is gimballed it shall be protected by a crash bar or other means to prevent it being tilted inadvertently when it is free to swing and a strap, portable bar or other means shall be provided to allow the cook to be secured in position, with both hands free for working, when the vessel is rolling. Means shall be provided to isolate the gimbaling mechanism.

4.3 Wherever a galley is provided in any vessel that is proceeding on a voyage of 24 hours or more the galley shall be equipped with a refrigerator for the safe storage of perishable food and adequate cupboard space for the secure storage.

5 Toilet facilities

5.1 Adequate toilet facilities, separated from the rest of the accommodation, shall be provided for persons on board, the floor of which shall have a non-slip surface.

5.2 In determining the requirements for water closets and wash basins the number of persons carried, the anticipated length of voyages and the area of operation should be considered.

5.3 In vessels with overnight accommodation separate seafarer and passenger facilities shall be provided where possible.

6 Stowage facilities for personal effects

Adequate stowage facilities for clothing and personal effects shall be provided for each person on board.

7 Cooking and heating

7.1 Cooking and heating equipment shall be suitable for marine use and shall be designed and installed to the satisfaction of the Administration.

7.2 Gasoline shall not be used for cooking, heating or lighting on board a vessel.

7.3 Subject to **IX/7.4**, fire places or other heating and cooking equipment with open flames shall not be used on board a vessel.

7.4 Liquefied and non-liquefied gases may be used as cooking fuels where the installation of such system is to the satisfaction of the Administration. Open gas flame appliances, other than cooking stoves, domestic refrigerators or water heaters are not permitted. Spaces containing any such stoves or water heaters shall have adequate ventilation to remove fumes and possible gas leakage to a safe space. All pipes conveying gas from a container to an appliance shall be of steel or other appropriate material. Automatic safety gas shut-off devices shall be fitted to operate on loss of pressure in the gas main pipe or flame failure on any appliance.

7.5 Storage of gas containers/cylinders should be well ventilated, isolated from other spaces on the ship and only accessible from the open deck.

8 Noise and vibration

Noise and vibration levels on board shall be to the satisfaction of the Administration with appropriate measures taken to minimise both.

9 First aid kit

9.1 This section applies to all vessels regardless of date of construction.

9.2 A vessel shall carry a first aid kit approved by the Administration. The kit shall consist of a watertight container capable of holding all the items specified in **Annex 8**, with directions for use, stowed in a suitable container that is marked, “First Aid Kit”. A first aid kit shall be easily visible and readily available to seafarers.

10 Passenger accommodation

10.1 This section applies to all passenger vessels regardless of date of construction.

10.2 All passenger accommodation shall be arranged and equipped to provide for the safety of the passengers in consideration of the route, modes of operation and speed of the vessel.

10.3 The height of deckheads in a passenger accommodation space shall be at least 1.9 m but may be reduced at the sides of a space to allow for camber, wiring, ventilation ducts and piping. The space shall be maintained to minimise fire and safety hazards and to preserve sanitary conditions. Aisles shall be kept clear of obstructions.

10.4 A berth to the satisfaction of the Administration shall be provided for each passenger to be carried in overnight accommodation spaces, save that for voyages not exceeding 24 hours a reclining chair may be provided in lieu of a berth.

10.5 A seat shall be provided for each passenger permitted in a space for which the fixed seating criterion in **IX/11.2.3** has been used to determine the number of passengers permitted. A seat shall be constructed to minimise the possibility of injury and avoid trapping occupants. Installation of seats shall

provide for ready escape. Seats, including fixed, temporary or portable seats, shall be arranged as follows:

- .1 An aisle of not more than 3.8 m in overall length shall be not less than 610 mm in width;
- .2 An aisle of more than 3.8 m in overall length shall not be less than 760 mm in width;
- .3 Where seats are in rows, the distance from seat front to seat front shall not be less than 760 mm and the seats shall be secured to a deck or bulkhead.

10.6 Seats identified in the determination of the maximum number of passengers permitted shall be secured to the deck, bulkhead or bulwark by effective permanent or temporary means.

10.7 The free deck area must be supplied with adequate and appropriately secured handrails for the number of standing passengers in accordance with **IX/11.2.1**.

11 Passenger capacity

11.1 This section applies to all passenger vessels regardless of date of construction.

11.2 The maximum number of passengers permitted in any passenger vessel shall be the greatest number permitted by any of the following criteria or combination of these criteria.

- .1 Length of Rail - one passenger may be permitted for each 760 mm of rail space available to the passengers at the periphery of the deck, not including rail space in congested areas, on stairways and where persons standing in the space would block the vision of the vessel's operators.
- .2 Deck Area - one passenger may be permitted for each square metre of free deck area available for the passengers' use. Free deck area does not include:
 - .1 Concession stands, fixed tables, fixed gambling equipment and similar furnishings;
 - .2 Toilets and washrooms;
 - .3 Companionways and stairways;
 - .4 Spaces occupied and necessary for handling lifesaving equipment or line handling gear or in way of sail booms or running riggings;
 - .5 Spaces below deck which are unsuitable for passengers or which would not normally be used by passengers;
 - .6 Interior passageways less than 760 mm wide and passageways on open deck less than 460 mm wide;

- .7 Bow pulpits, swimming platforms and areas which do not have a solid deck, such as netting on multi-hull vessels;
 - .8 Deck areas in way of paddle wheels; and
 - .9 Aisle area.
- .3 Fixed Seating - one passenger may be permitted for each 460 mm of width of fixed seating provided (see **IX/10.5**).

11.3 Different passenger capacity criteria may be used on each deck of a vessel and added together to determine the maximum number of passengers to be carried on that vessel. Where seats are provided on part of a deck and not on another, the number of passengers permitted on a vessel may be the sum of the number permitted by the seating criterion for the space having seats and the number permitted by the deck area criterion for the space having no seats. The length of rail criterion may not be combined with either the deck area criterion or the fixed seating criterion when determining the maximum number of passengers permitted on an individual deck.

11.4 The Administration may give special consideration to increasing the passenger allowances for a vessel operating on short runs on protected waters, such as a ferry.

12 Surface of working decks

12.1 This section applies to all vessels regardless of date of construction.

12.2 The surface of a working deck shall be non-slip. Acceptable surfaces are:

- .1 chequered plate;
- .2 unpainted wood;
- .3 a non-skid pattern moulded into fibre-reinforced plastic (FRP);
- .4 non-slip deck paint; or
- .5 an efficient non-slip covering.

12.3 A hatch cover fitted on a working deck shall have a non-slip finish.

12.4 In an inflatable boat or rigid inflatable boat the upper surface of the inflated buoyancy tube shall be provided with a non-slip finish.

13 Protection from mosquitoes

13.1 This section applies to all vessels regardless of date of construction.

13.2 Vessels regularly trading to and within mosquito infested ports shall be fitted with devices to protect seafarers from mosquitoes.

PART B - HOURS OF REST

14 General

14.1 This part applies to all vessels.

14.2 Administrations shall take account of the danger posed by fatigue of seafarers, especially those whose duties involve the safe and secure operation of a ship.

14.3 All persons who are assigned duty as officer in charge of a watch or as a rating forming part of a watch and those whose duties involve designated safety, prevention of pollution and security shall be provided with a rest period of not less than:

- .1** a minimum of 10 hours of rest in any 24-hour period; and
- .2** 77 hours in any 7-day period.

14.4 The hours of rest may be divided into no more than two periods, one of which shall be at least 6 hours in length, and the intervals between consecutive periods of rest shall not exceed 14 hours.

14.5 Administrations shall require that records of daily hours of rest of seafarers be maintained.

14.6 Parties may allow exceptions from the required hours of rest in **IX/14.3.2** and **IX/14.4** above provided that the rest period is not less than 70 hours in any 7-day period.

14.7 Exceptions from the weekly rest period provided for in **IX/14.3.2** shall not be allowed for more than two consecutive weeks. The intervals between two periods of exceptions on board shall not be less than twice the duration of the exception.

PART C - MANNING

15 General

15.1 This part applies to all vessels.

15.2 Every ship shall be manned with sufficient appropriately trained and medically fit seafarers as determined by the Administration.

15.3 It shall be the duty of an owner of a vessel to which this regulation applies to notify in writing to the Administration:

- .1** the geographical limits within which he proposes that the vessel be navigated;

- .2 the number of seafarers in addition to the master whom the owner considers it appropriate that the vessel should carry when being navigated within the geographical limits so notified; and
- .3 whether the owner considers it appropriate that, when the vessel is being so navigated, a seafarer should be the holder of a licence of any grade under the Code.

15.4 The Administration may approve:

- .1 the number of seafarers notified in accordance with **IX/15.3.2**; and
- .2 that a seafarer is to be, or that no seafarer need be, the holder of a licence in accordance with a notification under **IX/15.3.3**.

15.5 A vessel to which this regulation applies shall not proceed on a voyage or excursion unless:

- .1 the Administration has been notified in accordance with **IX/15.3**;
- .2 the Administration has given an approval in accordance with **IX/15.4**; and
- .3 the manning of the vessel is in accordance with the approval given under **IX/15.4**.

15.6 Any approval given under this regulation shall be in writing and shall specify the date on which it takes effect and the conditions, if any, on which it is given.

15.7 Medical fitness requirements are contained in chapter **X/14**.

15.8 Each Administration shall establish, for the purpose of preventing alcohol abuse, a limit of not greater than 0.05% blood alcohol level (BAC) or 0.25 mg/l alcohol in the breath or a quantity of alcohol leading to such alcohol concentration for masters, officers and other seafarers while performing designated safety, security and marine environmental duties.

PART D – MARITIME LABOUR CONVENTION 2006 EQUIVALENT STANDARDS AS APPROVED BY THE ADMINISTRATION

16 Application

16.1 Maritime Labour Convention (MLC 2006) equivalent standards shall apply to all SCV Code vessels except for daytime operations of open boats or domestic vessels in protected waters where national employment legislation will apply as appropriate.

17 Minimum age

17.1 The minimum age to work on board a ship is 16. Night work under the age of 18 is prohibited. However, a seafarer aged 16 or 17 may work at night if the work forms part of an established training program.

17.2 The age for Masters and Engineers is specified in chapter **X Part A**.

18 Medical certification

18.1 All seafarers must be medically fit to work on board a ship. A medical fitness certificate shall be required according to chapter **X/14**.

19 Qualifications of seafarers

19.1 The qualifications of the Master and Engineers are provided in chapter **X Part A** and Tables **X/5.2, X/9.2** and **Annex 11/1.2**.

19.2 Other seafarers shall have minimum qualifications stated in **Annex 11/1.2**.

20 Seafarers' employment agreements (SEA)

20.1 A Seafarers' employment agreement (SEA) must be issued to all seafarers. The following particulars should be included:

- .1** The seafarers' full name, date of birth or age and birthplace.
- .2** The shipowner's name and address.
- .3** The place where and date when the seafarers' employment agreement is entered into.
- .4** The date of engagement and date of completion of the SEA.
- .5** The capacity in which the seafarer is to be employed.
- .6** The seafarers wages, including overtime and allowances where applicable.
- .7** The amount of paid or unpaid annual leave.
- .8** The conditions for termination of the SEA. Minimum 7 days' notice.
- .9** Health and social security benefits.
- .10** Repatriation where applicable.
- .11** Any other particulars which national law may require.
- .12** Both parties are to sign the SEA and receive a copy.

21 Use of any licensed or certified or regulated private recruitment and placement service

21.1 No need for a licensed employment agency applies where engagement of seafarers directly is

made by the owner. If an employment agency is used it should be a certified agency.

22 Hours of work or rest

22.1 Hours of work or rest shall be in accordance with chapter **IX/14**.

23 Manning levels for the vessel

23.1 The manning level of vessels is in accordance with chapter **IX/15**. The Flag Administration approves the manning level taking into consideration type of ship, manned or unmanned engine, length of voyages, number of persons on board, etc.

24 Accommodation and recreational facilities

24.1 The accommodation of the existing vessels should be in accordance with chapter **IX Part A**. The standards of accommodation and recreational facilities specified in **Annex 14** shall be applicable to all vessels keel laid down on or after 1 July 2018.

24.2 The accommodation and recreational facilities should comply with the substantial equivalent standards specified in **Annex 14** taking into consideration the type of voyages as specified in chapter **IX/1.4 and 2.2**. The Flag Administration to approve crew and passenger accommodation plans for new ships as appropriate for the vessel.

24.3 When modifications to accommodation is made to the existing ships on or after 1 July 2018, the changes must be in compliance with **Annex 14**. The substantial equivalent standards should be as such that the vessels should not compromise the functionality, safety or stability.

24.4 Furthermore, the following matters should be taken into consideration when approving vessel's accommodation plan i.e. length of voyages, overnight run, day run only, number of persons on board and geographical location.

25 Food and catering

25.1 Food and catering services should be provided for vessels engaged in overnight voyages.

25.2 The seafarers working on a day voyage vessel operating less than 24 hours should be provided with drinking water and one meal or compensated if not supplied on board.

25.3 Seafarers are entitled to food and drinking water free of charge. The preparation of food must be carried out by a crew member having knowledge of health and hygiene acceptable by the flag Administration. Crew members, designated to prepare and handle food, must not be under the age of 18.

25.4 Food served on board should meet food hygiene, nutrient value and seafarers cultural and religious needs.

26 Health and safety, on-board medical care and accident prevention

26.1 It is the duty of the owner/manager and master to ensure the health and safety of seafarers onboard.

26.2 If there are more than 5 seafarers onboard then there is a requirement to have a designated safety official onboard.

26.3 This regulation makes no distinction between the duty of care towards workers and that towards others onboard. If there is a relevant risk to other persons, the employer must take reasonably practicable steps to avoid that risk.

26.4 Seafarers shall be entitled to medical care including dental treatment. All vessels must have first aid treatment facilities. Where any seafarer requires medical attention, beyond first-aid, doctor/hospital visits should be facilitated.

27 On board complaint

27.1 An effective and fair on-board complaint procedure shall be made available to seafarers. The procedure for on-board complaints is described in **Annex 16**.

28 Payment of wages

28.1 The **Seafarers' employment agreements (SEA)** must specify details of payment of wages including overtime, allowances if applicable, etc. The seafarers' wages to be paid into a bank account, if preferred by the seafarer, or otherwise as agreed by the seafarer.

28.2 A statement of monthly wages should be provided to seafarers and made available onboard for inspection if deemed necessary during the inspection of vessels.

29 Social security

29.1 The social security protection shall be applicable to all seafarers in accordance to the national regulations of the seafarers.

30 Financial security

30.1 The owner of the vessel shall ensure that there is in place suitable financial security to cover payments to seafarers in the event of abandonment which is defined as a situation where the shipowner;

- .1** fails to cover the cost of the seafarer's repatriation; or
- .2** has left the seafarer without the necessary maintenance and support; or
- .3** has otherwise unilaterally severed their ties with the seafarer including failure to pay contractual wages for a period of at least two months.

30.2 The owner of the vessel shall ensure that there is in place suitable financial security to cover payments to the seafarer in the event of contractual claims with respect to compensation in the event of:

- .1** death; or
- .2** long term disability due to an occupational injury, illness or hazard.

31 Access to shore-based welfare facilities

31.1 Seafarers shall have access to appropriate shore based welfare facilities.

32 Equivalent standard (MLC 2006) report

32.1 Vessels shall be issued with a Small Vessel Inspection Report as in **Annex 15 A or B**. This report shall be made available on board for inspection by relevant inspections authorities. SCV Code vessels will not require Declaration of Maritime Labour Compliance (DMLC) Part I and DMLC Part II.

**CHAPTER X
LICENCING OF BOATMASTERS AND ENGINEERS**

PART A - LICENCES

1 Master

1.1 A commercial vessel shall carry in command a person who is qualified as follows:

- .1** he or she is the holder of a licence issued by the Administration under regulation X/4 stating that he or she is qualified to have command of such a vessel;
- .2** the licence is in force and is of a grade appropriate in respect to the waters in which the vessel is being navigated, the size of the vessel and the number of passengers carried; and
- .3** the vessel is in an area specified in the licence as one in which a vessel may be navigated under the command of the holder; or

1.2 The holder of a certificate of competency as a Master issued in accordance with the provisions of the STCW Convention may command any vessel under the Code, subject to any limitations of that certificate of competency. Near Coastal voyage limitations may be considered acceptable for vessels covered by this Code.

2 Engineers

2.1 A commercial vessel fitted with main propulsion machinery of up to 750 kW, shall where an engineer is required by the Administration, carry as engineer a person who is qualified as follows:

- .1** he or she is the holder of a licence issued by the Administration under regulation X/4 stating that he or she is qualified to be in charge of the main and auxiliary machinery of such a vessel;
- .2** the licence is in force and is of a grade appropriate in respect both of the waters in which the vessel is being navigated and the size of the vessel; and
- .3** the vessel is in an area specified in the licence as one in which a vessel may be operated under the charge of the holder; or

2.2 The holder of a certificate of competency as an engineer officer issued in accordance with the provisions of the STCW Convention may be carried as engineer in any vessel under the Code, subject to any limitations of that certificate of competency.

2.3 Except as authorised by the Administration, vessels having main propulsion machinery of a power of 750 kW and over shall carry engineers qualified in accordance with the STCW Convention.

3 Other seafarers

3.1 A commercial vessel required by the Administration to carry seafarers, in addition to a Master and Boat Engineer, shall carry as such seafarers, persons who hold the additional qualifications identified in section 1.2 of **Annex 11** of the Code.

3.2 A passenger vessel shall carry Masters, Boat Engineers and Seafarers who have completed the training specified in section A-V/2, paragraphs, 1 (Crowd Management Training) and 4 (Safety Training for Personnel providing Direct Service to Passengers in Passenger Spaces) of the Seafarers, Training, Certification and Watchkeeping Code, (STCW Code) as required by the Administration.

4 Licence issue, standards and conditions

4.1 The Administration may issue licences as Boatmaster or Boat Engineer, as appropriate to persons who meet the requirements of this Regulation. The form of the Boatmaster and Boat Engineer licences are given in **Annex 10**.

4.2 An application for a licence under this regulation shall be made in such form as the Administration may from time to time specify.

4.3 Subject to **X/4.4**:

- .1** the standards of competence to be attained and the conditions, including conditions as to medical fitness, to be satisfied by a person in order for a licence to be issued under the Code;
- .2** any exceptions applicable with respect to any such standards or conditions;
- .3** the manner in which the attainment of any such standards or the satisfaction of any such conditions is to be evidenced; and
- .4** the conduct of any examinations and the conditions of admission to them;

shall be those specified in regulations **X/6** to **X/8** and **X/10** to **X/12** or those which may from time to time be specified by the Administration in a Shipping Notice.

4.4 Notwithstanding that an applicant for a licence under this regulation complies with the standards and satisfies the conditions specified by the Administration, the Administration shall not issue such a licence to the applicant unless it is satisfied, having regard to all the relevant circumstances, that the applicant is a fit person to be the holder of such a licence.

5 Grades and area restrictions of boatmaster licences

5.1 A licence as a Master issued under regulation **X/4.1** shall bear the title “Boatmaster Licence” and shall be of one of the following grades, which shall be stated in the licence:

Boatmaster Licence, Grade 1

Boatmaster Licence, Grade 2
Boatmaster Licence, Grade 3

5.2 The grade of licence appropriate in respect of a vessel when being navigated in waters specified in column (1) of **Table X/5.2**, being of the size or type specified in relation to those waters in column (2) of the Table shall be either that specified in relation to those waters and that size or type of vessel in column (3) of the Table or, where the grade so specified is 2 or 3, a higher grade than that so specified:

TABLE X/5.2

(1) Waters	(2) Size and type of vessel	(3) Minimum Grade of Licence
Protected	Open Boat (<i>daylight only</i>)	3
	< 24 m	2
Coastal	Open Boat (<i>daylight only</i>)	3
	< 12 m passenger	2
	< 24 m other than passenger	2
	12 – 24 m passenger	1
Exposed	All vessels	1

5.3 Where a vessel, the master of which is required to hold a licence, has sails as its principal means of propulsion a sail endorsement is required. The requirement for a sail endorsement is a practical test on boat handling as detailed in **Annex 11-1.3**.

5.4 A Boatmaster licence of any grade shall be subject to such restriction as the Administration may determine as to the area or areas in which a vessel may be navigated under the command of the holder; and every such restriction shall be stated in the licence.

6 Requirements for obtaining a boatmaster licence

6.1 In order to obtain a Boatmaster Licence Grade 3 an applicant shall:

- .1 be eighteen years of age or over;
- .2 have submitted a valid medical certificate in accordance with **X/14**;
- .3 have completed a course of practical instruction under a licenced Boatmaster in sail or power vessels of appropriate size as approved by the Administration;
- .4 produce a *VHF Certificate* as evidence of having obtained the additional qualifications stated in **Annex 11-1.2.2**; and
- .5 have passed an examination for Boatmaster Grade 3.

6.2 In order to obtain a Boatmaster Licence Grade 2 an applicant shall:

- .1** be twenty years of age or over;
- .2** have submitted a valid medical certificate in accordance with **X/14**;
- .3** have completed a course of practical instruction under a licenced Boatmaster in sail or power vessels of appropriate size as approved by the Administration;
- .4** have completed approved seagoing service of not less than 2 months in accordance with the requirements of the Administration;
- .5** produce documentary evidence of having obtained the additional qualifications stated in **Annex 11-1.2**; and
- .6** have passed the examination for Boatmaster Grade 2.

6.3 In order to obtain a Boatmaster Licence Grade 1 an applicant shall:

- .1** be twenty one years of age;
- .2** have submitted a valid medical certificate in accordance with **X/14**;
- .3** have completed a course of practical instruction under a licenced Boatmaster in sail or power vessels of appropriate size as approved by the Administration;
- .4** have completed approved seagoing service of not less than 4 months in accordance with the requirements of the Administration;
- .5** produce documentary evidence of having obtained the additional qualifications stated in **Annex 11-1.2**; and
- .6** have passed the examination for Boatmaster Grade 1.

7 Practical instruction

Where an applicant is required to have had practical instruction this will be construed as his or her having enough experience to demonstrate proper boat handling skills in whatever craft or vessel the experience may have been given. However, it should be borne in mind that the prospective licence holder needs to demonstrate adequate knowledge of the methods of controlling, handling and directing vessels in emergencies, on the vessels, which he will be entitled to command.

8 Examination for boatmaster licences

8.1 A Boatmaster examination for Grades 2 and 3 consists of two parts. The first of which is an oral examination in which applicants will be tested on their knowledge of safety, navigation, rule of the road and seamanship subjects and also how they respond to certain emergency situations. The second part

consists of a practical test carried out on the size of vessel for which the applicant needs a licence. This test requires applicants to demonstrate their ability to handle the vessel in various circumstances.

8.2 The Boatmaster examination for Grade 1 consists of three parts. The first part of which is an oral examination in which applicants will be tested on their knowledge of safety, rule of the road and seamanship subjects and also how they respond to certain emergency situations. The second part consists of a practical test in chartwork and the use of electronic aids to navigation. The third part is a practical test carried out on a vessel of 12 m to 24 m in length. This test requires applicants to demonstrate their ability to handle the vessel in various circumstances.

8.3 An applicant passing only one part of the examination will be allowed to retain the pass in that part for a period of one year subject to the applicant being the holder of a valid medical fitness certificate when re-sitting the other part.

8.4 Details of the syllabus for each grade are contained in **Annex 11-1.1**.

8.5 Administrations may utilise written examination or computer based assessment to assist with assessment in oral examinations.

9 Grade and area restrictions of boat engineer licences

9.1 A licence as engineer issued under regulation **X/4** shall bear the title “Boat Engineer Licence” and shall be of one of the following grades, which shall be stated in the licence.

Boat Engineer Licence, Grade 1

Boat Engineer Licence, Grade 2

9.2 The grade of licence appropriate in respect of a vessel when being operated in waters specified in column (1) of **Table X/9.2**, being of the size specified in relation to those waters in column (2) of the Table shall be either that specified in relation to those waters and that size of vessel in column (3) of the Table or, where the grade so specified is 2, a higher grade than that so specified:

TABLE X/9.2

(1) Waters	(2) Size of vessel	(3) Minimum Grade of Licence
Protected	< 24 m	No licence required
Coastal	15 – 24 m	2
Exposed	< 24 m	1

9.3 A Boat Engineer licence of any grade shall be subject to such restriction as the Administration may determine as to the area or areas in which a vessel may be operated under the charge of the holder; and every such restriction shall be stated in the licence.

9.4 A person required to hold a Boat Engineer Licence on a passenger vessel must also have completed six months service whilst holding the appropriate certificate.

10 Requirements for obtaining a boat engineer licence

In order to obtain a Boat Engineer Licence of Grade 1 or Grade 2 an applicant shall:

- .1** be eighteen years of age or over;
- .2** have completed an approved course on the repair and maintenance of engines and associated systems on seagoing vessels as required for the Grade of Licence sought;
- .3** have submitted a valid medical certificate;
- .4** produce documentary evidence of having obtained the additional qualifications stated in **Annex 11-1.2.1**; and
- .5** have passed the examination for Boat Engineer Grade 1 or Grade 2 as appropriate.

11 Approved course

11.1 An approved course is a course approved by the Administration, which covers the syllabus given in **Annex 11-2**. A Certificate of Attendance will be given by the course organisers to persons satisfactorily completing the course.

11.2 Persons who are able to demonstrate to the satisfaction of the Administration that they have appropriate engineering experience may be granted an exemption from the requirement to attend an approved course.

12 Examination for boat engineer licences

12.1 A Boat Engineer examination for Grades 1 and 2 consists of an oral examination in which applicants shall be tested on their knowledge of marine engines, propulsion systems, auxiliary machinery systems outboard engines, safe working practices and how the candidate responds to certain emergency situations.

12.2 The examination for a Boat Engineer Licence shall be based on the syllabus given in **Annex 11-2** at a level appropriate to the Grade of Licence applied for and its range of application.

12.3 A candidate who is unsuccessful in the examination shall resit the entire examination.

12.4 Administrations may utilise written examination or computer based assessment to assist with assessment in oral examinations.

13 Period of validity and renewal of licence

13.1 Licences shall be subject to re-validation every three years for persons up to 63 years of age and

annually for persons 63 years of age and over. Re-validation will be subject to the holder having proof that he or she has had, in the case of persons up to 63 years of age, at least 45 days service and in the case of persons 63 years of age and over, at least 15 days service, in vessels for which the licence is valid during that time. Revalidation is also subject to the submission of a medical certificate in accordance with regulation **X/14**.

13.2 Applicants unable to provide proof of service required by **X/13.1** shall satisfy the Administration of continued professional competence through test or re-examination.

13.3 A licence shall only remain valid so long as the person to whom it is issued holds a valid medical fitness certificate.

14 Medical fitness certificate

14.1 A medical fitness certificate in accordance with the requirements of the Administration shall be submitted with the initial application for a Boatmaster or Boat Engineer licence and for the re-validation of a licence. To obtain this an applicant is required to undergo a medical examination and have an eyesight test for colour and vision in accordance with the requirements of the Administration.

15 Record and surrender of licences.

15.1 The Administration shall make and, during the period of the licence, retain a copy of every licence issued under this Chapter.

15.2 A record of:

- .1** every licence issued under this Part; and
- .2** every suspension, cancellation or alteration of and any other matter affecting such a licence;

shall be kept, in such manner as the Administration may require, by the Registrar of Shipping or by such other person as the Administration may direct.

Annex 1

FORM OF SCV SAFETY CERTIFICATE

[COUNTRY LOGO]	[COUNTRY NAME] SMALL COMMERCIAL VESSELS SAFETY CERTIFICATE FOR VESSELS OPERATING IN THE CARIBBEAN			This certificate applies from:
				Date of Expiry:
VESSEL NAME	TYPE	CALL SIGN	MMSI	
HOME PORT	IDENTITY MARK	POWER	PROPULSION	
PLACE BUILT	HULL MATERIAL	DATE BUILT	LENGTH (L)	
OWNER		OPERATOR		
THIS VESSEL SHALL BE MANNED WITH THE FOLLOWING PERSONNEL:				
	TITLE	MINIMUM GRADE	NUMBER	
MASTER				
MATE(S)				
ENGINEER(S)				
DECK RATING(S)				
ENGINEER RATING(S)				
MINIMUM TOTAL SEAFARERS:				
THIS VESSEL MAY CARRY _____ PASSENGERS PLUS _____ SEAFARERS FOR A TOTAL PERSONS ALLOWED OF _____				
OPERATING AREA AND CONDITIONS OF OPERATION				
MAXIMUM ALLOWABLE TRIM _____				
MINIMUM FREEBOARD AMIDSHIPS _____				
WITH THIS INSPECTION HAVING BEEN COMPLETED AT _____ ON _____				
THIS VESSEL IS CONSIDERED TO BE IN COMPLIANCE WITH THE CODE OF SAFETY FOR SMALL COMMERCIAL VESSELS OPERATING IN THE CARIBBEAN AS APPLIED BY THE _____ (insert) _____ REGULATIONS				
THIS CERTIFICATE SHALL REMAIN VALID UNTIL ITS DATE OF EXPIRY SUBJECT TO THE ANNUAL SURVEYS BELOW BEING CARRIED OUT WITHIN 3 MONTHS EITHER SIDE OF THE ANNIVERSARY DATE (BASED ON DATE OF EXPIRY) EACH YEAR.				
ANNUAL SURVEY			THIS CERTIFICATE ISSUED BY:	
<i>DATE</i>	<i>PLACE</i>	<i>SIGNATURE</i>		
			(SIGNATURE OF AUTHORIZED OFFICIAL)	
			(DESIGNATION)	
			(DATE)	

Annex 1

Form of SCV Safety Certificate

(Regulation I/16.1)

VESSEL NAME	IDENTITY MARK	CERTIFICATION DATE	PAGE
RECORD OF LIFESAVING APPLIANCES AND FIREFIGHTING EQUIPMENT			
TOTAL EQUIPMENT PROVIDED:		Master shall maintain detailed records of safety equipment and servicing as required.	
LIFEBOATS (TOTAL)	LIFEJACKETS (ADULT)	FIRE PUMPS (FIXED)	
For a total number of persons =	LIFEJACKETS (CHILD)	FIRE PUMPS (POWER DRIVEN)	
RESCUE BOATS (Not included in lifeboat total)	LIFEJACKETS (OVERSIZE/ INFANT)	FIRE PUMPS (PORTABLE)	
MEANS OF RECOVERY OF PERSONS FROM WATER	LIFE BUOYS (TOTAL)	BUCKET (with lanyard)	
THROW OVER INFLATABLE RAFTS	WITH LIGHTS*	FIRE EXTINGUISHERS	
For a total number of persons =	WITH LINE ATTACHED*	FIRE HYDRANT	
DAVIT LAUNCHED INFLATABLE RAFTS	OTHER*	FIRE HOSE	
For a total number of persons =	HAND HELD DISTRESS FLARE	FIRE HOSE LENGTH	
LIFE FLOATS/BUOYANT APPARATUS	ROCKET DISTRESS FLARE	FIRE BLANKET	
For a total number of persons =	ORANGE SMOKE FLARE	FIRE AXE	
* INCLUDED IN TOTAL			
FIXED EXTINGUISHING SYSTEMS			
SPACE PROTECTED	AGENT	CAPACITY	
GPS	EPIRB	ECHO SOUNDER	
RADAR	SART	FIRST AID KIT	
VHF with DSC	NAUTICAL PUBLICATIONS (Detail)	SPEED LOG	
VHF without DSC	WEATHER INFORMATION RETRIEVAL SYSTEM		
GMDSS SAT'C'			
CHARTS (Detail)			
NAUTICAL PUBLICATIONS (Detail)			
EQUIVALENCIES			
EXEMPTIONS			
REMARKS			
DRY DOCKING & OTHER EXAMINATIONS			
LAST INTERMEDIATE:		NEXT DUE:	
LAST RENEWAL:		NEXT DUE:	
LAST RUDDER:		NEXT DUE:	
SHAFT & PROPELLOR:		NEXT DUE:	

Annex 2**SIMPLIFIED STABILITY TEST PROCEDURE**

Name of Vessel ----- Documentation No. ----- Date -----

Owner/Representative ----- Inspector -----

Location ----- Wind: Relative Direction ----- Vel ----- kts

Mooring Arrangement -----

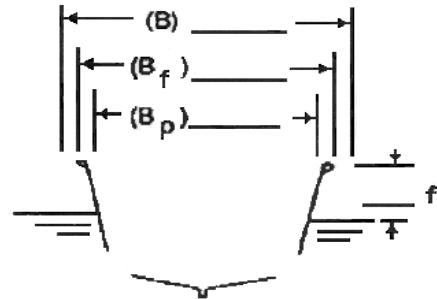
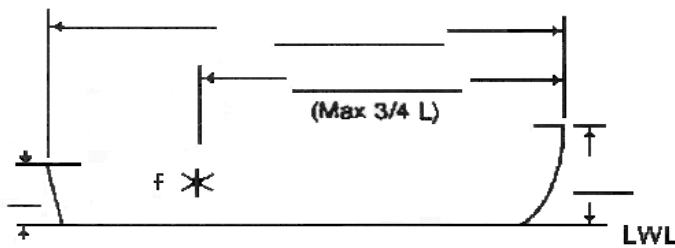
Route ----- Check One Coastal Protected**Indicate on above Sketch**

- 1) Profile of sheer line.
- 2) Length overall (LOA)
- 3) Station for measuring Reference Freeboard¹² (f) above load waterline (LWL), located in way of least freeboard or at a point $\frac{3}{4}$ (LOA) from the stem if the least freeboard is aft of this point..
- 4) Freeboard at bow
- 5) Freeboard at stern.

Indicate on above Sketch

- 1) Round or "V" shaped bottom
- 2) Maximum beam (B) to outside of shell; greater or equal to (B_f).
- 3) Maximum beam (B_p) accessible to passengers.
- 4) Maximum beam (B_f) on deck in way of Reference Station.
- 5) Reference Freeboard (f), height of sheer line above the LWL, in way of Reference Station.
- 6) Height of weather deck (including cockpit deck, if any) above load waterline in way of Reference Station.

All of the above measurements are to be taken in the loaded condition without list (III/8.6).

Measurements for (L), (B), and (B_f) are to exclude rub rails. If the vessel carries passengers¹³ on diving excursions, the total weight of the diving gear must be included in the loaded condition. If the vessel has a cockpit or well deck, show same by dotted line on the above sketches and indicate length (/).

¹² Freeboard shall be the distance from the sheer line to the load waterline. The sheer line shall be taken as the intersection of the side shell with the weather deck. Where calculations require "gunwale top" to be used, the following applied: For a cockpit vessel, the gunwale top shall be measured along an imaginary extension of the sheer line in way of the cockpit. For an open boat, the gunwale top shall be considered the sheer line.

¹³ Passengers include seafarers.

(1) TOTAL TEST WEIGHT REQUIRED:

$$\text{----- X -----} = \text{-----}$$

of Pax Wt/Pax Total Test WT. (W)

Notes:

- a) "Test Weight" defines only the weight to be moved during the test. Weights used to represent missing equipment or stores shall be considered part of the "loaded condition."
- b) The maximum number of passengers shall not exceed the number computed in accordance with **SCV Code IX/11**.
- c) Weight per passenger equals 82.5 kg.

(2) DISTRIBUTION OF TEST WEIGHT:

- a) Distribute the test weight fore and aft so as to obtain the normal operating trim.
- b) Arrange the test weight so that its vertical center of gravity (CG) is approximately 760 mm above deck.
- c) The vertical distribution of the test weight shall be such as to simulate the most unfavourable vertical CG likely to occur in service. On vessels having one upper deck above the main deck available to passengers, the vertical weight distribution shall not be less severe than the following:

Total test weight (w) = -----

Passenger capacity of upper deck:

$$\text{----- X ----- X 1.33} = \text{-----}$$

of Pax Wt/Pax Weight on Upper Deck

Weight on
Main Deck

(3) WIND HEEL CALCULATION:

- a) With the vessel in the loaded condition, block off the profile of the vessel into rectangles using vertical lines starting at the load waterline, as shown below. Include passenger railings, canopies and spotting towers.
- b) Measure, on the vessel, the length and height (V) of each rectangle and enter into the table on Sheet 3.
Complete the calculations in the table, add the products in the last column and enter the sum in Section (4) (b). Multiply this sum by the appropriate (P) value to obtain the Wind Heeling Moment (M_w) in Section (4) (b) on page 3.

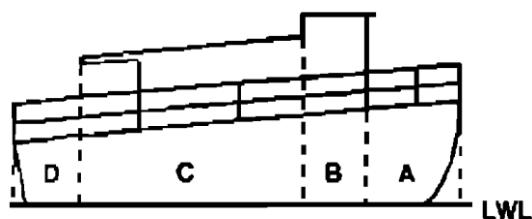

Value of (P)	kg/m ²
Exposed	73.2
Partially Protected	48.8
Protected	36.6

(continued on page 3 of 8)

(5) LOCATION OF IMMERSION MARK (i) ABOVE LOAD WATERLINE PRIOR TO APPLICATION OF HEELING MOMENT:

The freeboard measurement (f) shall be taken with the weight required in Step (1) on board. The height of the immersion mark (i) shall be the lesser of the two values provided by (a), (b), (c) or (d) according to vessel type, or (e) for all vessels. The mark (i) shall be placed on the hull above the LWL at the reference station.

$$i = \underline{\hspace{10em}}$$

(a)	<p>Flush Deck Type Sailing Vessels (or well deck vessels that operate on protected waters, have non return scuppers, and the reference freeboard is not more than one quarter of the distance from the waterline to the top of the gunwale).</p> <p>Reference freeboard (f) is measured to the top of the weather deck at the side of the vessel.</p> $\frac{\underline{\hspace{10em}}}{\text{Reference freeboard (f)}} = \frac{\underline{\hspace{10em}}}{\text{Height of (i) above LWL}}$	
(b)	<p>Flush Deck Type Vessels (including all well deck vessels except those noted in (a) above) For well deck vessels, freeboard (f) to the lowest deck exposed to the weather must equal or exceed 25 cm.</p> <p>If less than 25 cm, use 5(d) Open-boat Type formula</p> $\frac{\underline{\hspace{10em}}}{\text{Reference freeboard (f)}} / 2 = \frac{\underline{\hspace{10em}}}{\text{Height of (i) above LWL}}$	
(c)	<p>Cockpit Type Vessels Freeboard to cockpit deck must equal or exceed 25 cm If less than 25 cm, use 5 (d) Open—boat Type formula Length(L) Length of cockpit.....(/) Reference freeboard(f) (measured to top of gunwale) Height of immersion mark above LWL.....(i) All measurements shall be in metres</p>	<p>Exposed Waters</p> $(i) = \frac{f(2L - 1.5/)}{4(L)}$ <hr/> <p>Coastal or Protected Waters</p> $(i) = \frac{f(2L - /)}{4(L)}$
(d)	<p>Open-boat Type Vessels Reference freeboard (f) is measured to top of gunwale</p> $\frac{\underline{\hspace{10em}}}{\text{Reference freeboard (f)}} / 4 = \frac{\underline{\hspace{10em}}}{\text{Height of (i) above LWL}}$	
(e)	<p>All Vessel Types To limit the final angle of list to 14° for any type of vessel, the height of the immersion mark (i) shall on no case exceed the value below. If this value is less than that produced by (a), (b), (c) or (d) above, whichever applicable, then this value shall be used for (i).</p> $\frac{\underline{\hspace{10em}}}{\text{Beam at Reference Station}} / 8 = \frac{\underline{\hspace{10em}}}{\text{Max height of (i) above LWL for any type of vessel}}$	

(6) WEIGHT MOVEMENT:

- a) The heeling moment required by Section (4) shall be obtained by a transverse movement of the test weights.
- b) The test shall be conducted with all tanks $\frac{3}{4}$ full, ballast aboard in place, all portlights secured, and any non-return valves or flaps on scuppers or deck drains restrained in the open position.
- c) The vessel shall be fully afloat and all mooring are to be slack during the test.
- d) During the loading and moving of test weights, care should be taken if there is evidence of low stability. This may be assumed to be the case whenever the effect of any added or shifted weight increment is noted to be more than that of the preceding increment of the same size, or when the chine or bilge amidships comes out of the water as a result of the heel.
- e) Care is to be exercised that the vessel is not heeled excessively either due to weight movement or superimposed roll which could cause the test weights to topple or ship's gear to become adrift.
- f) While the vessel is heeled, check for open seams, loose hull fittings, etc., which are not normally immersed and which could cause flooding of the vessel.

Quality	Weight per Unit	Distance Moved	Moment
Total Heeling Moment			

(7) HEIGHT OF IMMERSION MARK (I) ABOVE WATERLINE AFTER WEIGHT MOVEMENT:

$$i = \text{-----}$$

- a) If the vessel lists to the immersion mark (i) before the full heeling moment is applied, the test shall be stopped and the vessel fails the test.
- b) When the moment required in Section (4) has been developed, measure the resulting height of the immersion mark (i) above the waterline.
- c) If any portlights are found to be near the waterline at the final angle of the list, such portlights on each side shall be permanently closed.
- d) If any scuppers or drains are found to be below the waterline at the final angle of list so as to permit entry of water into the or onto the deck, such openings on each side shall be fitted with automatic non-return valves.

(8) GENERAL STABILITY INFORMATION (for documentation purposes only)

Tankage

Tank	Capacity	Approximate Location of CG @ 100% Cap.	
		Aft of Stem	Above Top of Keel

Ballast:

Material	Weight	Approximate Location of CG	
		Aft of Stem	Above Top of Keel

TWENTY-FIVE PERCENT TEST

(This test is not a necessary part of the Simplified Stability Test Procedure but may be used as a preliminary Check when the stability is believed to be marginal)

1. After the Total Test Weight (W) has been placed on board and the Reference Freeboard (f) has been measured, rig a pendulum free to swing athwartships at any convenient location on the vessel. Arrange it so that the bob is approximately 3 mm above the deck. Place a chalk mark on the deck directly beneath the bob. Measure the pendulum length (pend. 1) as the distance from pivot to deck.
2. Move the test weight to obtain a heeling moment equal to one-quarter of the Required Heeling Moment in Section (4) on page 3. It is suggested that the weights having the longest levers be moved as to minimize the amount of weight handled.

One – quarter Heeling Moment: ----- /4 = ----- Req'd H.M. (4)

3. After the weight has been moved, place a chalk mark on the deck directly beneath the pendulum bob. Measure the pendulum deflection (pend. D.) as the distance between chalk marks.

4. Before proceeding with the Simplified Stability Test Procedure, the following calculations may be carried out to anticipate the results:

Approximate Maximum allowable Heeling Moment: $\frac{2 \times \text{-----} \times \text{-----} \times \text{-----}}{\frac{1}{4} \text{ H.M.} \quad \text{pend. 1.} \quad \text{Height of (i) = -----}}$ $\text{-----} \times \text{-----}$ <p style="text-align: center;">pend.d. Beam at Ref. Station (B_f)</p>	
If the Maximum Allowable Heeling Moment is LESS than the Required Heeling Moment in Section (4) on page 3, the vessel will probably fail the test by the difference indicated below. Required Heeling Moment = ----- Allowance Heeling Moment = ----- Difference = -----	
If Passenger Heel (4a) applies: Approximate Number of Passengers in Excess 6 x _____ Difference = _____ <div style="text-align: right; margin-right: 50px;"># of Pax</div> _____ X _____ Wt/Pax (B _p)	If Wind Heel (4b) applies: Approximate Excess Wind Moment (Sum A x H) ----- / ----- = ----- Difference (P) Moment

STABILITY TEST PROCEDURE FOR VESSELS CARRYING PASSENGERS AND CARGO

- (1) For vessels carrying cargo as well as passengers, follow the same test procedure as for vessels carrying passengers alone except that, in addition to the passenger test weight, the maximum deadweight of cargo permitted shall be on board, in place and so arranged as to simulate the most unfavourable vertical center of gravity likely to occur in service.
- (2) Specify the maximum cargo deadweight permitted to be carried:

Weight of Cargo	Approximate Location of CG	
	Aft of Stem	Above Top of Keel

- (3) Complete the Twenty-Five Percent Test based on the Passenger Heeling Moment or the Wind Heeling Moment, whichever is applicable, and note the anticipated test results.
- (4) If the anticipated results of the test indicates that the vessel will fail, the entire test must be repeated with a reduced number of passengers and/or a reduced amount of cargo, or by utilizing any other corrective measures available.
- (5) If the anticipated results of the test indicates that the vessel will pass, then with the vessel in the heeled condition and being cautious not to disturb any of the test weights which were shifted in order to heel the vessel; remove approximately one-quarter of the cargo from the vessel exercising great care to remove it symmetrically about the centerline.
 - (a) If the pendulum deflection DECREASES or remains unchanged
 - replace the cargo which was removed and complete the stability test procedure.
 - (b) If the pendulum deflection INCREASES
 - the cargo may be improving the stability of the vessel. Therefore, remove all of the cargo from the vessel, replace the test weights in their original positions so as to remove all list, remeasure the Reference Freeboard (f), and repeat the Twenty-Five Percent Test in its entirety for the new condition of loading. If the second Twenty-Five Percent Test indicates that the vessel will pass, complete the stability test procedure.
- (6) If the vessel passes the stability test procedure under these conditions, it is deemed to have adequate stability for the safe carriage of passengers allowed regardless of whether or not cargo, not in excess of the amount specified in item (2) above, is carried.

Annex 2(A)

Page 1 of 1

STABILITY INFORMATION

The format of the stability booklet and the information included will vary dependent on the vessel type and operation. Units of measure used in the stability booklet must agree with the units of measure of the draft markings.

- 1 In developing the stability booklet, consideration must be given to the following information:
 - .1 A general description of the vessel, including lightweight data.
 - .2 Instructions on the use of the booklet.
 - .3 General arrangement plans showing watertight compartments, closures, vents, downflooding angles, and allowable deck loadings.
 - .4 Hydrostatic curves or tables.
 - .5 Capacity plan showing capacities and vertical, longitudinal centres of gravity of stowage spaces and tanks.
 - .6 Tank sounding tables showing capacities, vertical centres of gravity in graduated intervals and showing free surface data for each tank.
 - .7 Information on loading restrictions, such as a maximum KG of minimum GM curve that can be used to determine compliance with applicable intact and damage stability criteria.
 - .8 Examples of loading conditions.
 - .9 A rapid and simple means for evaluating other loading conditions.
 - .10 A brief description of the stability calculations done including assumptions.
 - .11 General precautions for preventing unintentional flooding.
 - .12 A table of contents and index for the booklet.
 - .13 Each ship condition which, if damage occurs, may require cross-flooding for survival and information concerning the use of any special cross-flooding fittings
 - .14 The mount and location of fixed ballast.
 - .15 Any other necessary guidance for the safe operation of the vessel under normal and emergency conditions.
 - .16 For each self-propelled hopper dredge with a working freeboard, the maximum specific gravity allowed for dredge spoil.

Annex 3

Sheet 1 of 5

SMALL COMMERCIAL VESSEL SIMPLIFIED SUBDIVISION CALCULATION

Name of Vessel_____	Official No._____	Route_____
Owner or Representative		
Present at Measurement_____	Inspector_____	Date_____
Location of Vessel at		
Time of Measurement_____	No. of W.T. Bhds._____	No. of Passengers_____

INSTRUCTIONS

- 1 The vessel is to be in maximum load condition except that the fuel and water tanks are to be three-quarters full. Ballast, if required, is to be on board and in place. A capacity load of persons, cargo, vehicles, stores, etc., is to be on board (or weight equivalent thereto) in proper location.
- 2 The vessel is to be afloat in water of a density not greater than that of the route for which she is to be certificated, i.e., salt water.
- 3 The vessel is to be in her normal trim, i.e., at a waterline established by the normal distribution of the weight on board. If there is a slight list it is to be corrected by transverse movement of some of the weight on board so that the vessel is upright in the water.
- 4 The measurements specified on sheet 4 are to be carefully taken and recorded as indicated in steps (5) or (6) as applicable to the type of vessel. The length (LOA) is the length of the hull proper, measured over the bulkhead deck, and shall not include fishing platforms, bowsprits, guards, etc. The depth (D) is especially important and should be double-checked. If this particular dimension cannot be measured amidships, as required, due to obstructions, etc., it is to be made at points fore and aft of, and equidistant from amidships and the mean thereof shall be recorded as (D). The beam (B) shall be measured amidships to the outside of the hull and shall not include the guards. The freeboards (f) shall be measured at the bulkheads from the load waterline to the top of the bulkhead deck at the side. The distance from the stem to each bulkhead shall be indicated on the plan in the same manner as bulkhead "A".
- 5 Where the vessel has no portlights which can be opened and is flush decked with normal sheer or no sheer, record the dimensions on sheet 4 and proceed as indicated in step (7).
- 6 Where the vessel has portlights which can be opened, or if it is flush decked with reverse sheer, or if it has a raised deck forward (as in the case of the typical cockpit boat), do not use the sketch on sheet 4. Instead, prepare to accurate scale a profile of the hull above the load waterline, locate the bulkheads, and the portlights, if any, draw in the "corrected bulkhead deck line" as shown on sheets 2 or 3, and then proceed as indicated in step (7).

7 Subdivision Calculation

Sheet 2 of 5

(a) **For Reverse Sheer:**

Draw a straight line from the stem (at the top of the bulkhead deck) to the stern (at the top of the bulkhead deck at the side) to establish the “corrected bulkhead deck line”.

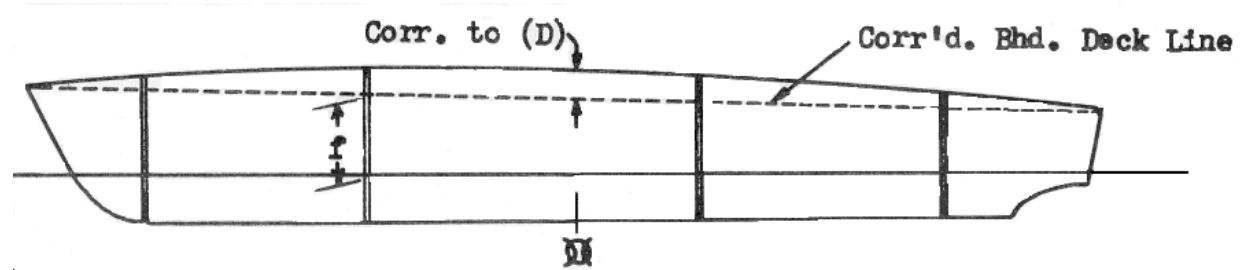
(b) **For Raised Deck:**

Draw a straight line from the bulkhead deck at the stem to the top of the foremost of the bulkheads which extend to the lower bulkhead deck, to establish the “corrected bulkhead deck line”.

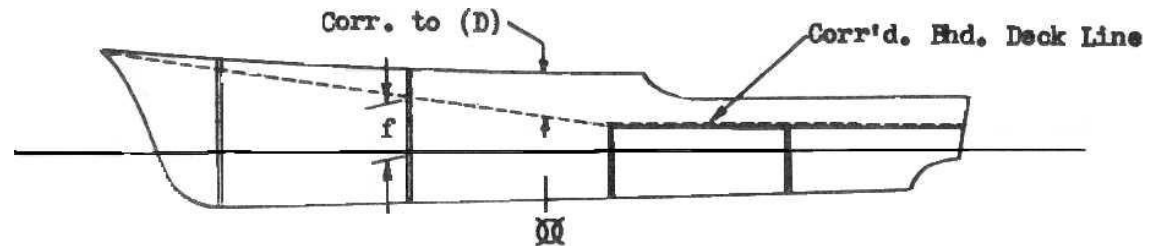
(c) **For Vessels of Any Type Having Portlights Which Open:**

The “corrected bulkhead deck line” shall be a line which extends from the stem at the actual bulkhead deck, passes not less than 75 mm below the portlights and thence to the stern at the actual bulkhead deck. This line shall not be, at any point, above the corrected bulkhead deck line which would be indicated from the same hull if portlights were not installed.

FLUSH DECK TYPE

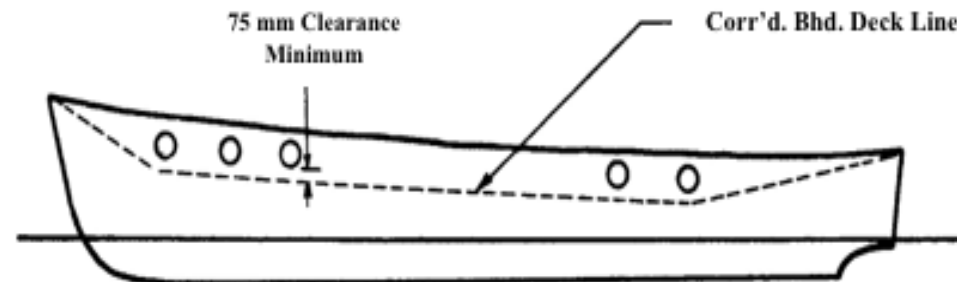

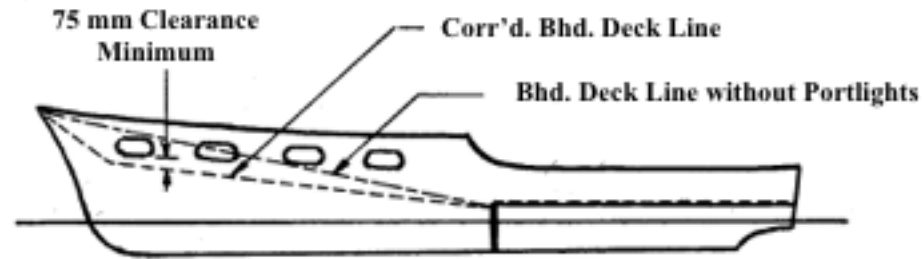
RAISED DECK TYPE:

Sheet 3 of 5

The freeboards at each bulkhead are to be scaled, on the drawing, to this corrected bulkhead deck line. Also, the distance amidships measured from this line upward to the top of the actual bulkhead deck at the side shall be deducted from the depth (D), which was measured as shown on sheet 4, to obtain the correct (D) to be used with these types of hulls.

- 8 From the dimensions recorded on sheet 4 (or on the specially prepared profile) and the factors listed below, complete the table on sheet 5. The actual compartment lengths should not exceed the calculated permissible compartment lengths – OR – LOA/3 whichever is the least.

Midpoint of Compartment in Percent (LOA) from Bow	Floodable Length Factor
0-15%	.33
20	.34
25	.36
30	.38
35	.43
40	.48
45	.54
50	.61
55	.63
60	.58
65	.53
70	.48
75	.44
80	.40
85	.37
90-100	.34

Name of Vessel _____ Official No. _____

Sheet 4 of 5

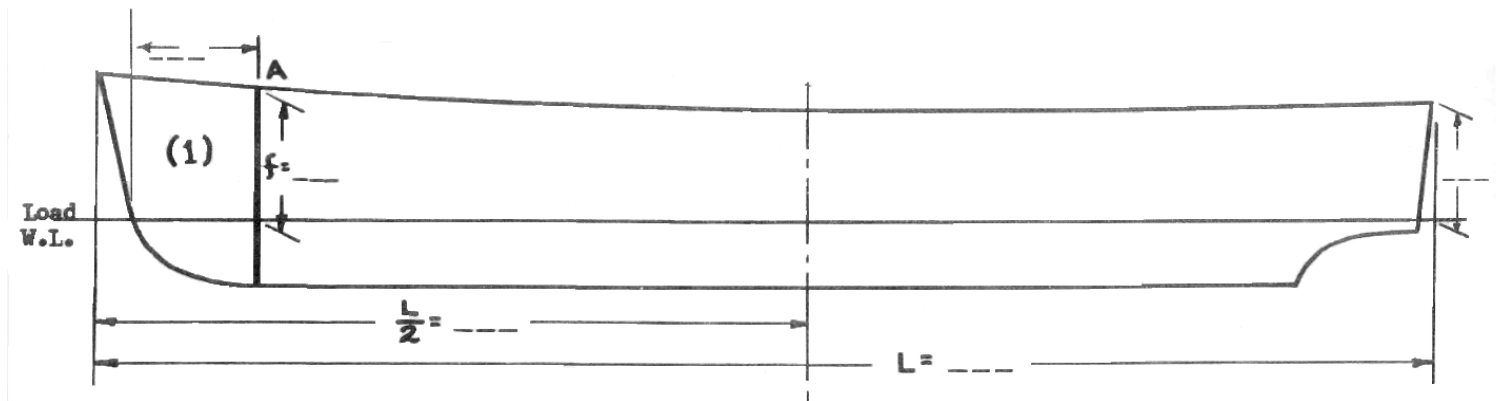

1. Draw in other W.T. bulkheads. Indicate distance from stem and freeboard for each as shown for Bulkhead "A".
2. Freeboards "x" and "y" Amidships must be equal.
3. Record all dimensions.
4. Indicate water density at time of measurement.
 Salt Brackish Fresh

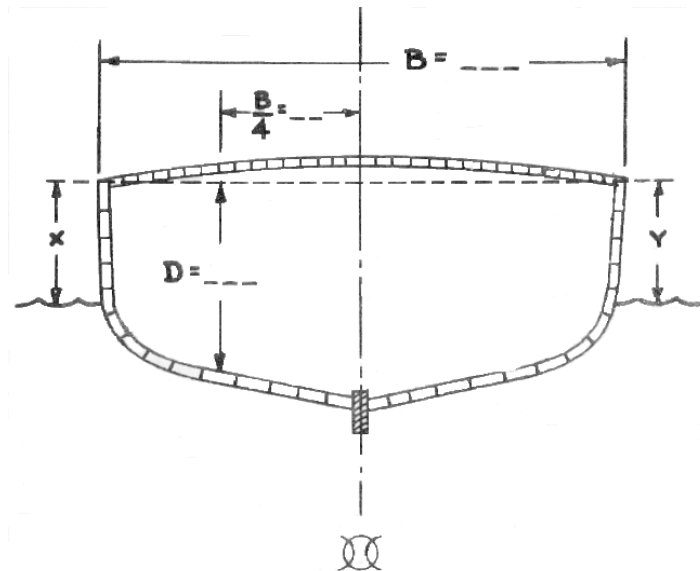

$\frac{L}{D} = \text{---} = \text{---}$

Maximum Length of Any Compartment
$\frac{L}{3} = \frac{\text{---}}{3} = \text{---}$

Annex 4***FIRE TEST FOR FRP*****1 Heat Source**

The heat source for the fire tests should be provided by a propane gas torch with a Sievert burner type No. 2944 giving a maximum flame temperature of 1,600°C and burning propane at the rate of 4,110 grams per hour with a pressure of 2 kgf/cm. The rate of burning should be carefully controlled. The length of blue flame should be approximately 200 mm.

2 Specimen

The specimen should be 450 mm x 450 mm cut from a one metre square panel of the laminate to be tested. The specimen should not incorporate any of the edges of the one metre square panel. The edges of the specimen should be housed in a steel frame sufficiently to prevent them igniting during the tests. The specimen should be cured for at least 28 days before testing.

3 Test procedure

The specimen should be oriented vertically in a draft free location, such that the tip of the blue flame, i.e. the point of greatest heat, impinges on the centre of the specimen with the flame normal to its surface. The non gel coat surface of the specimen should be exposed to the flame. The flame should not burn through the specimen within 15 minutes.

Annex 5**IGNITABILITY TEST FOR COMBUSTIBLE INSULATIONS****1 Test Specimens**

1.1 One specimen is to be prepared.

1.2 The specimen is to be a minimum of 150 mm x 150 mm and of the thickness which is to be used on the vessels, together with any facing with which it is normally covered.

2 Conditioning of Test Specimens (absorbent materials)

2.1 The conditioning atmosphere should have a temperature of $20 \pm 2^{\circ}\text{C}$ and relative humidity of 65 %.

2.2 The specimen should be laid flat, in the conditioning atmosphere for a period 24 hours, or for a sufficiently longer period in order to ensure that the mass of the specimen shows no progressive change greater than 0.25% when it is determined at intervals of 2 hours.

3 Atmosphere for Testing

3.1 The test is to be conducted in an atmosphere the same as for conditioning the specimen, or within 2 minutes of removal from the conditioning atmosphere.

3.2 Appropriate measures should be taken to prevent draughts in the vicinity of the testing equipment when testing is in progress.

4 Testing Procedure**4.1 Source of Ignition**

The source should be obtained by using a burner consisting of a copper tube having a length of 150mm and inside and outside diameters of 5mm and 6mm respectively connected by plastic or rubber tubing to a gas tap supplying natural gas. The copper tube is to have no opening for the supply of air.

4.2 Height of Flame

Before the test takes place the burner flame is to be adjusted to a height of 32 mm.

4.3 Test Procedure

4.3.1 Place the specimen horizontally on a metal tripod stand with the upper surface of the specimen facing downwards (i.e. with normally exposed face on underside) such that the height of this surface of the specimen is approximately 8 mm below the top of the burner flame. Apply the burner flame at right angles to the plane of the specimen in the centre of specimen. After one minute the burner flame is to be removed clear of the specimen and the time in seconds to extinction of any flaming is to be recorded.

4.3.2 The test in paragraph **4.3.1** is to be repeated after any flaming or smouldering has ceased and the temperature of the specimen has returned to normal except that the centre of the burner flame is to be positioned at the midpoint of any edge of the specimen. Again the time in seconds to extinction of any flaming after the removal of the burner is to be recorded.

5 Pass Criteria

An insulation is deemed to be “not readily ignitable” when any flaming of the test specimen ceases within 20 seconds of the removal of the burner.

Annex 6**RECOMMENDED EMERGENCY BROADCAST INSTRUCTIONS**

The following emergency broadcast instructions, when placed on a placard, will satisfy the requirement contained in regulation **VII/5.3** for an emergency broadcast placard:

- 1** Make sure your radiotelephone is on.
- 2** Select 156.8 MHz (channel 16 VHF) or 2182 kHz. (Channel 16 VHF and 2182 kHz on SSB are for emergency and calling purposes only).
- 3** Press microphone button and, speaking slowly – clearly – calmly, say:
 - .1** “MAYDAY-MAYDAY-MAYDAY” for situations involving Immediate Danger to Life and Property; or
 - .2** “PAN-PAN-PAN” for urgent situations where there is No Immediate Danger to Life or Property.
- 4** Say: “THIS IS (INSERT VESSEL’S NAME), (INSERT VESSEL’S NAME), (INSERT VESSEL’S NAME), (INSERT VESSEL’S CALL SIGN), OVER.”
- 5** Release the microphone button briefly and listen for acknowledgement. If no one answers, repeat steps **3 & 4**.
- 6** If there is no acknowledgement, or if the Coast Guard or another vessel responds, say: “MAYDAY” OR “PAN”, (INSERT VESSEL’S NAME).”
- 7** DESCRIBE YOUR POSITION using latitude and longitude coordinates, or range and bearing from a known point.
- 8** STATE THE NATURE OF THE DISTRESS.
- 9** GIVE NUMBER OR PERSONS ABOARD AND THE NATURE OF ANY INJURIES.
- 10** ESTIMATE THE PRESENT SEAWORTHINESS OF YOUR VESSEL.
- 11** BRIEFLY DESCRIBE YOUR VESSEL: (INSERT LENGTH, COLOR, HULL TYPE, TRIM, MASTS, POWER, AND ADDITIONAL DISTINGUISHING FEATURES).
- 12** Say: “I WILL BE LISTENING ON CHANNEL 16/2182.”
- 13** End message by saying: “THIS IS (INSERT VESSEL’S NAME & CALL SIGN).”
- 14** Where your situation permits stand by the radio to await further communications with the Coast Guard or another vessel. If no answer, repeat, then try another channel.

Annex 7

ANCHORS AND CABLES

<u>Length Overall + Lwl</u> 2	Anchor Mass		Anchor Cable Diameter			
	Main	Kedge	Main		Kedge	
			Chain	Rope	Chain	Rope
(metres)	(kg)	(kg)	(mm)	(mm)	(mm)	(mm)
6	8	4	6	12	6	10
7	9	4	8	12	6	10
8	10	5	8	12	6	10
9	11	5	8	12	6	10
10	13	6	8	12	6	10
11	15	7	8	12	6	10
12	18	9	8	14	8	12
13	21	10	10	14	8	12
14	24	12	10	14	8	12
15	27	13	10	14	8	12
16	30	15	10	16	8	12
17	34	17	10	-	8	14
18	38	19	10	-	8	14
19	42	21	12	-	10	14
20	47	23	12	-	10	14
21	52	26	12	-	10	14
22	57	28	12	-	10	16
23	62	31	12	-	10	-
24	68	34	12	-	10	-

Notes:

1. The anchor sizes given are for high holding power (HHP) types.
2. When a vessel has unusually high windage due to any combination of high free-board, large superstructure or deck equipment outfit, the mass of anchor given above shall be increased to take account of the increase in wind loading.
For vessels of unusual or non-conventional ship form (including pontoon barges) the anchor size shall be to the satisfaction of the Administration.
The diameter of the anchor cable shall be appropriate to the increased mass of anchor.
3. Chain cable diameter given is for short link chain. Chain cable should be sized in accordance with ISO 4565:1986 - Anchor chains for small craft, or equivalent.
4. The rope diameter given is for nylon construction. When rope of another construction is proposed, the breaking load should be not less than that of the nylon rope specified in the table.
5. When anchors and cables are manufactured to imperial sizes, the metric equivalent of the anchor mass and the cable diameter shall not be less than the table value.
6. Lwl is the waterline length of the vessel when the vessel is floating at the assigned free-board draught.

Annex 8***FIRST AID KITS*****1 Type and Size**

First-aid kits shall be of the water-tight cabinet carrying type capable of holding the items specified in paragraph 4.

2 Construction and Workmanship

The container shall be of substantial and rugged construction, with the body, handle and all fittings of a corrosion-resistant material or suitably protected against corrosion to the satisfaction of the Administration.

3 Marking

Each approved first-aid kit shall be permanently marked with the following information: name of manufacturer, trade name symbol, model number, or other identification used by the manufacturer and the words "FIRST-AID KIT". The expiry dates of any of the contents are to be clearly marked.

4 Contents

4.1 Items shall be properly labelled to designate the name of contents and method of use. Each package shall be enclosed in a jacket of tough, transparent material, properly sealed, which shall be watertight. Vials for tablets shall not be made of glass.

4.2 The items contained in the first-aid kit for vessels operating in exposed or coastal waters shall be as listed in either **Table A8** or **Table B8**:

4.3 The items contained in the first-aid kit for vessels operating in protected waters shall be as listed in **Table C8**.

TABLE A8

Items	Number
Adhesive Elastic Dressing 7.5 cm x 4 cm	1
Assorted Adhesive Plasters	20
Medium Standard Dressing No 9	2
Large Standard Dressing No 15	2
Extra Large Standard Dressing No 3	1
Paraffin Gauze Dressings 10 cm x 10 cm	10
Calico Triangular Bandage 90 cm x 127 cm	4
Sterile Gauze Swabs 7.5 cm	5
Loperamide Capsules 2 mg (Diarrhoea Treatment)	20
Hyoscine Hydrobromide Tablets 0.3 mg (Sea Sickness Tablets)	60
Paracetamol Tablets 500 mg	65
Ibuprofen 400 mg	50
Glyceryl Trinitrate Spray (Preparation to Treat Angina)	1
Laerdal Pocket Mask/Mouth Resuscitation Aid	1
Cetrimide Cream 50 g	1
Pairs Disposable Latex Gloves Large	5
Burn Bag	1
Scissors Stainless Steel 12 cm	1
Medium RUSTLESS Safety Pins	6
Sutures 75 mm	6
Pack 10-Antiseptic Wipes	1

Table B8 (USCG-46 CFR 160.41)

Items	Number
Bandage compress – 10 cm	5
Bandage compress – 5 cm	8
Waterproof adhesive compress – 2.5 cm	32
Triangular bandage – 100 cm	3
Eye dressing packet, 4 g Ophthalmic ointment, adhesive strips, cotton pads	3
Bandage, gauze, compressed, 2 cm by 550 cm	2
Tourniquet	1
Forceps	1
Scissors	1
Safety pins	12
Wire splint	1
Ammonia inhalants	10
Iodine applicators (½ ml swab type)	10
Aspirin, phenacetin and caffeine compound, 6½ gr. tablets, vials of 20	5
Sterile petrolatum gauze, 8 cm x 46 cm	12

TABLE C8

Items*	Number
Assorted plasters	12
Eye pad	1
Triangular bandage	1
Safety pins	6
Medium sized dressing	1
Large sized dressing	1
Paraffin Gauze Dressings 10 cm x 10 cm	2
Bandage conforming 7.5 cm	1
Pair disposable gloves	1
Ibuprofen 400 mg	10
Alcohol free moist wipes	6
Pair tuff-cut scissors	1
Yellow clinical waste bag	1
Emergency foil blanket	1
Face shield resuscitation device	1
First aid guidance leaflet	1
Sterile eye wash in eye wash bottle	1

* The items contained in the first-aid kit for vessels operating in protected waters, as a minimum, should be carried for every 50 persons on board.

4.4 Vessels operating within the limits of a port should adhere to local port regulations when additional requirements are specified.

4.5 Instructions

Instructions for the use of the contents of the first-aid kit shall be printed in legible type on a durable surface and shall be securely attached to the inside of the cover. Vessels utilising **Table A8** should also carry the latest edition of either St Johns, St Andrews, or Red Cross First Aid Manual.

The instructions for the use of the contents listed in **Table B8** are as follows:

DIRECTIONS FOR THE USE OF THE FIRST-AID KIT

Item Title	Remarks
Ammonia inhalants	Break one and inhale for faintness, fainting, or collapse.
Aspirin, phenacetin, caffeine tablets	Chew up and swallow 2 tablets every three hours for headache, colds, minor aches, pains, and fever. Maximum of 8 in twenty-four hours.
Bandage compress, 10 cm and 5 cm	Apply as a dressing over wound. DO NOT touch part that comes in contact with wound.
Bandage, gauze, compressed, 5 cm	For securing splints, dressings, etc.
Bandage, triangular, compressed	Use as arm sling, tourniquet, or for retaining splints or dressings in place.
Burn dressing	The petrolatum gauze bandage is applied in at least two layers over the burned surface and an area extending 5 cm beyond it. The first dressing should be allowed to remain in place, changing only the outer, dry bandage as needed, for at least 10 days unless signs of infection develop after several days, in which case the dressing should be removed and the burn treated as an infected wound. Watch for blueness or coldness of the skin beyond the dressing and loosen the dressing if they appear.
Compress, adhesive, 2.5 cm	Apply as dressing over small wounds. DO NOT touch part that comes in contact with wound.
Eye patch	Apply as dressing over inflamed or injured eye.
Forceps	Use to remove splinters or foreign bodies. DO NOT dig.
Ophthalmic ointment	Apply in space formed by pulling lower eyelid down, once daily for inflamed or injured eyes. DO NOT touch eyeball with tube.
Splint, wire	Pad with gauze and mould to member to immobilize broken bones. Hold in place with bandage. DO NOT attempt to set the bone.
Tincture of iodine, mild	Remove protective sleeve, crush tube and apply swab end. DO NOT use in or around eyes.
Tourniquet	For control of haemorrhage. Loosen for a few seconds every 15 minutes.

Annex 9

ESTIMATING GUIDELINES FOR HOLDING TANK CAPACITY

1 These calculations shall be used as guidelines, as capacities are not mandated. The capacity of each Marine Sanitation Device (MSD) should be evaluated in terms of the vessel's size, route, service, and particular circumstances. These capacities consider only "black-water" toilet drains. On the average, each person will produce 0.4 litres of waste per day.

2 Flush Rate. **Table A9-1** estimates the water used per flush by different toilet systems.

**TABLE A9-1
APPROXIMATE FLUSH CAPACITIES FOR VESSEL TOILETS
DRAINING TO MARINE SANITATION DEVICES**

System Type	Litres per flush
Conventional (flushometer)	19.0
Recirculating	0.4
Vacuum	1.1
Hand Pump	1.9
Electric Pump	3.8

3 Wastewater produced. **Table A9-2** estimates the litres of wastewater produced per person per day, based on the plumbing type, and the way the boat operates.

**TABLE A9-2
LITRES OF WASTEWATER PER PERSON
PER DAY BASED ON PLUMBING TYPE**

Trip Length	User	Conv.	Recirc.	Vacuum	Hand Pump	Electric
LONG (Note 1)	Seafarers	96	1.9	7.2	11	20
	Passengers	96	1.9	7.2	11	20
MEDIUM (Note 2)	Seafarers	96	1.9	7.2	11	20
	Passengers	31	0.64	7.2	3.8	6.8
SHORT (Note 3)	Seafarers	48	0.95	3.6	7.4	10
	Passengers	24	0.95	1.9	2.6	5.1

Note

- 1** Seafarers and passengers aboard 24 hour/day.
- 2** Seafarers aboard 24-hour/day; 2 groups of passengers aboard for 4 hours each (2 trips/day), each passenger using facilities once.
- 3** All Seafarers aboard 12 hour/day; 6 groups of passengers aboard for 2 hours (6 trips per day), one fourth of passengers using facilities once.

Annex 10

FORM OF BOATMASTER AND BOAT ENGINEER LICENCE

COAT
OF
ARMS

BOATMASTER LICENCE GRADE 1/2/3
Issued by the
[ADMINISTRATION]
under the provisions of the
Code of Safety for Small Commercial Vessels

PHOTOGRAPH

No.....

This is to certify that

.....
is entitled to serve in a capacity requiring a Boatmaster Grade 1/2/3 in commercial vessels of
..... metres in length operating in *Protected/Coastal/Exposed* waters.

The holder is further entitled to serve in such other vessels and in such areas as may be endorsed on this certificate.

ENDORSEMENT:

Date of Issue:

Date of Expiry:

.....
Signature of Holder

OFFICIAL
STAMP

.....
Director of [Maritime Affairs]

This Licence is valid only if the holder is in possession of a valid medical fitness certificate

COAT
OF
ARMS

BOAT ENGINEER LICENCE GRADE 1/2
issued by the
[ADMINISTRATION]
under the provisions of the
Code of Safety for Small Commercial Vessels

PHOTOGRAPH

No.....

This is to certify that

.....
is entitled to serve in a capacity requiring a Boat Engineer Grade 1/2 in commercial vessels with an
installed power of less than 750 kW operating in *Coastal/ Exposed* waters.

The holder is further entitled to serve in such other vessels and in such areas as may be endorsed on this certificate.

ENDORSEMENT:

Date of Issue:

Date of Expiry:

.....
Signature of Holder

OFFICIAL
STAMP

.....
Director of [Maritime Affairs]

This Licence is valid only if the holder is in possession of a valid medical fitness certificate.

Annex 11**SYLLABUS FOR BOATMASTER AND BOAT ENGINEER LICENCES****1. BOATMASTER LICENCE SYLLABUS****1.1 Syllabus Requirements**

The syllabus below will be modified by the Examiner to take into account the equipment on board the vessel.

For instance, it is unlikely that open boat vessels operating solely in bays or harbours will be provided with a compass and an applicant would not be examined in this subject.

This syllabus may be used immediately but shall apply for examinations conducted after 1 July 2018.

Syllabus Content		Grade		
		3	2	1
A. PRACTICAL TEST (This test should take place on a vessel of a type for which the applicant is requiring a licence).				
1	Boat Handling:			
.1	Berthing and unberthing	Y	Y	Y
.2	Coming to and weighing anchor	Y	Y	Y
.3	Making fast to and leaving a buoy	Y	Y	Y
.4	Boat manoeuvring in confined waters	Y	Y	Y
.5	Turning short round	Y	Y	Y
.6	Knowledge and effect of transverse thrust	Y	Y	Y
.7	Steering a compass course and taking a rough bearing	Y	Y	Y
.8	Practical demonstration on the use of VHF on board the applicant's vessel. The holder must have knowledge of procedures used in radio telephone (VHF and MF) communications particularly with respect to distress, urgency, safety and navigational messages and of the adverse effect of misuse of such equipment	Y	Y	Y
B. ORAL EXAMINATION				
B1	Emergency Situations:			
.1	Recovery of man overboard	Y	Y	Y
.2	Loss of engines	Y	Y	Y
.3	Loss of steering ability	Y	Y	Y
.4	Action to take in the event of collision	Y	Y	Y

Syllabus Content		Grade		
		3	2	1
.5	Grounding	Y	Y	Y
.6	Accident to seafarer or passenger	Y	Y	Y
.7	Use of extinguishing appliances	Y	Y	Y
.8	Basic fire prevention measures – “The Fire Triangle”	Y	*	*
.9	Use of lifesaving appliances	Y	Y	Y
.10	Search and rescue techniques in bad weather or reduced visibility		Y	Y
.11	Choosing an appropriate area for beaching		Y	Y
B2	REGULATIONS FOR PREVENTING COLLISION AT SEA:			
.1	A practical knowledge of the Rule of the Road as appropriate to the area of operation	Y	Y	Y
.2	A full knowledge of the regulations		Y	Y
.3	Keeping a good lookout	Y	Y	Y
.4	Keeping of a Deck Log		Y	Y
B3	LOCAL KNOWLEDGE AND REGULATIONS:			
.1	Actions to be taken in the event of injury or loss of life to a seafarer		Y	Y
.2	Certification required by the vessel		Y	Y
.3	Limits as to vessel operation	Y	Y	Y
B4	SEAMANSHIP:			
.1	Common nautical terms	Y	Y	Y
.2	Interaction with other vessels	Y	Y	Y
.3	The effect of wind and tide on the manoeuvrability	Y	Y	Y
.4	Securing and stowage of anchors and cable		Y	Y
.5	Selection of a proper anchorage		Y	Y
.6	The importance of navigating at reduced speed to avoid damage caused by own vessels bow or stern wave	Y	Y	Y
.7	The difference in handling of single screw and twin screw boats		Y	Y
.8	Basic knowledge of hazards associated with towing	Y	Y	Y
B5	CHARTWORK:			
.1	The meaning of common chart symbols		Y	Y
.2	The use of Tidal Diamonds		Y	Y
.3	Position fixing			Y
.4	Courses to steer allowing for current and leeway			Y

Syllabus Content		Grade		
		3	2	1
.5	Familiarity with the use of parallel rules, dividers, compasses, etc.			Y
B6	LIFE-SAVING AND FIRE-FIGHTING APPLIANCES:			
.1	A knowledge of the statutory requirements and appreciation of the fact that the person in charge of a vessel must be satisfied that the life-saving and fire-fighting appliances are properly maintained		Y	Y
.2	Use and deployment of inflatable liferafts and inflatable or rescue boats			Y
.3	Inflatable liferaft and boat servicing requirements			Y
.4	Hydrostatic release units			Y
.5	Maintenance and care of buoyant apparatus		Y	Y
B7	DISTRESS SIGNALS:			
.1	A knowledge of the contents of Annex IV of the Collision Regulations and the operation of the signals and equipment required to be carried in the applicant's vessel		Y	Y
.2	Coast Guard response to distress signals		Y	Y
.3	Action to aid location by rescuers	Y	*	*
.4	Actions prior to abandonment	Y	*	*
B8	PASSENGER SAFETY:			
.1	Safety announcements (<i>See regulation VIII/8</i>)	Y	Y	Y
.2	Disposition of passengers and seafarers to ensure stability and trim	Y	Y	Y
.3	Passenger numbers and reporting systems (<i>See regulation VIII/7</i>)	Y	Y	Y
.4	Knowledge of emergency instructions (<i>See regulation VIII/10</i>) and methods of orderly evacuation following any emergency, having regard to the size of the vessel concerned and its operational area		Y	Y
.5	Ability to demonstrate to passengers the use of personal lifesaving appliances	Y	Y	Y
B9	LEGAL RESPONSIBILITIES TOWARDS PASSENGERS AND SEAFARERS:			
.1	Safe access	Y	Y	Y
.2	Safe working practices	Y	Y	Y
.3	SCV Safety Certificate and regulations relating thereto (<i>See regulation I/15</i>)	Y	Y	Y
.4	Basic security issues	Y	Y	Y
B10	WEATHER:			
.1	Sources of information and the proper use of weather reports	Y	Y	Y
.2	Local conditions and effects	Y	Y	Y

Syllabus Content		Grade		
		3	2	1
.3	Signs of approaching bad weather	Y	Y	Y
B11	ENGINEERING KNOWLEDGE:			
.1	Basic knowledge of day to day engine and battery checks	Y	Y	Y
.2	Knowledge of the servicing and routine maintenance of propulsion and auxiliary machinery	Y	Y	Y
.3	Knowledge of safety and shut off devices	Y	Y	Y
.4	Basic knowledge of running checks	Y	Y	Y
.5	Methods of fault detection, correction and emergency repairs	Y	Y	Y
B12	PUBLICATIONS:			
.1	Merchant Shipping Notices (as applicable)			Y
.2	Regulations (as applicable)			Y
B13	PREVENTION OF POLLUTION:			
.1	A general appreciation of the Regulations applicable to the prevention of pollution			Y
.2	Knowledge of the factors contributing to and precautions to be observed to prevent marine pollution when pumping out bilges and particularly, when changing lubricating oil		Y	Y
.3	Knowledge that disposal into the sea of all plastics, including but not limited to synthetic ropes, plastic sheeting and garbage bags etc., is prohibited	Y	Y	Y
B14	ELECTRONIC AIDS TO NAVIGATION:			
.1	Knowledge of the use of Radar, Echo Sounder and Satellite Navigation or other position-finding device fitted on board the applicant's vessel		Y	Y
B15	BASIC KNOWLEDGE OF VESSEL CONSTRUCTION AND STABILITY:			
.1	General ideas on ship construction and on plans available on board the vessel, where these are carried			Y
.2	Maintaining watertight sub-division			Y
.3	General pumping arrangements			Y
.4	General principles of stability			Y
.5	Heeling forces and their causes			Y
.6	Wind Pressure on projected areas			Y
.7	Application and effects of asymmetric loading			Y
.8	Overtight mooring			Y
.9	Equilibrium in the heeled condition			Y

Syllabus Content		Grade		
		3	2	1
.10	Simple dynamic balance			Y
.11	Effect of liquid free surface and its control			Y
.12	Cranes, their operation and safe operating limits			Y
.13	Outline knowledge of freeboard and trim			Y
.14	The use of stability and hydrostatic data where provided			Y
.15	Knowledge of the effect of severe wind and rolling in associated sea conditions, especially in following seas		Y	Y
.16	Knowledge of the importance of not exceeding vessels load capacity	Y	Y	Y
.17	Hazards of enclosed space entry		Y	Y
B16	FIRST AID:			
.1	Knowledge of contents and instructions for the use of the first aid kit	Y	Y	Y
.2	Initial action, positioning and transportation of a casualty	Y	*	*
.3	Control of bleeding and improvised bandaging	Y	*	*
.4	Knowledge of basic resuscitation techniques	Y	*	*
.5	Knowledge of basic treatment of burns etc.	Y	*	*
.6	Knowledge of basic shock management and casualty needs	Y	*	*

* = covered in basic safety training courses

1.2 Ancillary Certificates

.1 Basic Safety Training Course

- .1 Basic Sea Survival – e.g. IMO Model Course 1.19
- .2 Elementary First Aid - e.g. IMO Model Course 1.13
- .3 Basic Firefighting Course - e.g. IMO Model Course 1.20
- .4 Personal Safety and Social Responsibility - e.g. IMO Model Course 1.21

.2 VHF Certificate: Every person in charge of a vessel which has a VHF set on board shall be the holder of a VHF Radiotelephone Operator licence.

.3 GMDSS general operator certificate: Every person in charge of a vessel which is operating in exposed waters shall be holder of the General Operator's Certificate.

1.3 Practical Sail Boat Test

This test is to take place on a vessel of a size for which the applicant is licenced.

- .1 Getting the boat away from a pier or wharf.

- .2 Bring the boat alongside a pier or wharf.
- .3 Securing to a pier or wharf.
- .4 Manoeuvring the boat to pick up a man overboard.
- .5 Manoeuvring the boat to pick up a mooring buoy or marker.
- .6 Be able to change tack.
- .7 Be able to sail to all points of the wind.
- .8 Anchoring and retrieving anchor.

2. BOAT ENGINEER SYLLABUS

This syllabus may be used immediately but shall apply for examinations conducted after 1 July 2018

Syllabus Content	Grade	
	2	1
2.1 Emergencies The following are some of which the candidate must be knowledgeable.		
.1 Assessment of damage and damage control		Y
.2 Temporary plugging of leaks	Y	Y
.3 Man overboard procedure	Y	Y
.4 Fire in the engine compartment	Y	Y
.5 Action to be taken in the event of ingress of seawater into the engine compartment	Y	Y
.6 Procedure to be followed in the event of partial or total electrical failure		Y
.7 Isolation of main engine units in the event of malfunction and the action necessary to continue safe operation.	Y	Y
.8 Action to be taken when abandoning the vessel	Y	Y
2.2 Operating Procedure The candidate should have knowledge in the following:		
.1 Method of preparation and checks prior to starting:		
.1 Checks prior to starting machinery	Y	Y
.2 Checks prior to engaging Clutches	Y	Y
.3 Checks of stern tube prior to starting	Y	Y
.4 Checks of propeller prior to starting	Y	Y
.5 Checks of steering gear prior to starting	Y	Y
.6 Checks of Sump level prior to starting	Y	Y
.7 Checks of Filters prior to starting	Y	Y
.8 Checks of Fuel system prior to starting	Y	Y
.9 Checks of Safety Equipment prior to starting	Y	Y
.2 Checks during running:		
.1 Machinery running checks	Y	Y

Syllabus Content		Grade	
		2	1
.2	Stern Tube running checks	Y	Y
.3	Steering Gear running checks	Y	Y
.4	Sump Level running checks	Y	Y
.5	Filter running checks	Y	Y
.3	Methods of fault detection, correction and emergency repairs		Y
.4	Precautions to ensure that machinery is not damaged due to misuse through overspeeding, overloading, lack of lubrication or by corrosion.	Y	Y
2.3	Prevention of Marine Pollution:		
.1	Regulations applicable to the prevention of pollution (a general appreciation.)		Y
.2	Factors contributing to and precautions to be observed to prevent marine pollution when pumping out bilges and particularly, when changing lubricating oil	Y	Y
.3	Knowledge that disposal into the sea of all plastics, including but not limited to synthetic ropes, plastic sheeting and garbage bags etc., is prohibited	Y	Y
2.4	Marine Engines		
	The candidate should have a thorough knowledge in the following areas:		
.1	Working principles of marine engines:		
.1	Two stroke and four stroke cycles	Y	Y
.2	Piston position, valve positions, timing etc.	Y	Y
.2	Comparison between diesel and gasoline engines:		
.1	Engine capacity	Y	Y
.2	Bore	Y	Y
.3	Difference between compression and electric spark ignition	Y	Y
.4	Fuel injection systems	Y	Y
.5	The weight of the engine block	Y	Y
.3	Air and exhaust systems:		
.1	Air fitters, manifolds, exhaust pipes and silences	Y	Y
.2	Use of pumps and blowers in air and exhaust systems	Y	Y
.3	Supercharging and its effects on the engine	Y	Y
.4	Fuel systems:		
.1	Types of fuel	Y	Y
.2	Fuel storage and transfer systems	Y	Y
.3	Effects on fuel of dirt and water contamination	Y	Y
.4	Fuel filters, separators, pumps, carburettors and fuel injection systems.	Y	Y
.5	The combustion and ignition process	Y	Y
.5	Cooling systems:		
.1	Mediums of cooling	Y	Y
.2	Heat exchangers	Y	Y
.3	Radiators	Y	Y
.4	Control of overheating	Y	Y
.5	Advantages and disadvantages of various cooling systems	Y	Y
.6	Corrosion and use of sacrificial anodes	Y	Y

Syllabus Content		Grade	
		2	1
.6	Lubrication systems:		
.1	Principles and purposes of lubrication	Y	Y
.2	Types of bearings and their fitting, care, lubrication, maintenance and adjustment	Y	Y
.3	Types and grading of lubricating oils	Y	Y
.4	Use of grease	Y	Y
.5	Sea water contamination and procedures after contamination	Y	Y
.7	Starting systems:		
.1	Hand recoil Starting Systems	Y	Y
.2	Electric Starting Systems	Y	Y
.3	Compressed air Starting Systems	Y	Y
2.5 Electrical Systems			
The candidate should have knowledge of the following areas:			
.1	General construction, care and maintenance of alternating and direct current generators	Y	Y
.2	Switch boards and shipboard circuitry	Y	Y
.3	Starters and their care and maintenance	Y	Y
.4	Batteries and their care and maintenance	Y	Y
.5	Operating precautions and dangers of explosion short circuits etc.	Y	Y
2.6 Pumps and Pumping Systems			
The candidate should have knowledge of the following areas:			
.1	Construction, care and maintenance of all types of pumps used on small vessels	Y	Y
.2	Causes of loss of output, methods of priming and maintenance of priming devices	Y	Y
.3	Arrangement of bilge water pumping systems	Y	Y
.4	Types of valve chests	Y	Y
.5	Causes of deterioration and leakage and its temporary and permanent repairs	Y	Y
.6	Procedure for getting rid of oily bilge-water.	Y	Y
2.7 Propulsion Systems			
The candidate should have knowledge of the following areas:			
.1	Stern tube:		
.1	Stern tube bearings	Y	Y
.2	Stern glands and packing	Y	Y
.2	Clutches and gear boxes	Y	Y
.3	Shafting:		
.1	Intermediate shafts	Y	Y
.2	Types of shaft bearings	Y	Y
.3	Types of shafts	Y	Y
.4	Shaft alignment checking and correction of misalignment	Y	Y
.4	Water-jet propulsion - principle of operation		Y
.5	Damage to and repair of propellers		Y
.6	Typical steering gear arrangement including mechanical, hydraulic and electro- hydraulic, emergency procedures, care and maintenance	Y	Y

Syllabus Content		Grade	
		2	1
2.8 Safe - Working Procedures			
The candidate should have knowledge of the following:			
.1	The use of instruction manuals which should be understood and clearly followed for both the operation and maintenance of the machinery	Y	Y
.2	The effective use of safety guards in way of all hot parts and moving parts for the safety of personnel	Y	Y
.3	Safety and shut off devices associated with fuel oil and lubricating oil systems	Y	Y
.4	The use of adequate protective equipment and clothing	Y	Y
.5	Selection of correct tools	Y	Y
.6	Safe use and care of all tools	Y	Y
.7	Selection of correct lifting methods and devices	Y	Y
.8	Safe use of all lifting devices	Y	Y
.9	Display of warning signs	Y	Y
.10	Cleanliness	Y	Y
.11	Enclosed space entry	Y	Y
2.9 Auxiliary Machinery and Systems			
The candidate should have knowledge in the following:			
.1	The general arrangement of single and multi-stage air compressors, their care maintenance and emergency repairs	Y	Y
.2	Basic principles of power hydraulics, hydraulic fluid systems for winches, steering gear etc. fault finding care and maintenance	Y	Y
.3	Electro-technology:		
.1	General principles of electricity - voltage, current, resistance	Y	Y
.2	Basic principles of alternating and direct current	Y	Y
.3	Effects of electric current; conductors and insulators; lamps; cable and fuses.	Y	Y
.4	The construction, capacity, care and maintenance of batteries.	Y	Y
.4	Deck Machinery; Winches and windlass, types, method of operation and maintenance		Y
.5	Refrigeration		Y
.6	Air Conditioning systems		Y
.7	Boilers		Y
2.10 Outboard Engines			
The candidate should have knowledge in the following:			
.1	Principles of two and four stroke engines and related valve and crank position	Y	Y
.2	The purpose and working of:		
.1	Flywheel	Y	Y
.2	Valves and scavenging	Y	Y
.3	Fuel system	Y	Y
.4	Ignition system	Y	Y
.5	Transmission	Y	Y
.6	Gear box	Y	Y
.7	Lubrication	Y	Y

Syllabus Content		Grade	
		2	1
.8	Cooling	Y	Y
.9	Starting	Y	Y
.3	Trouble identification:		
.1	Starting difficulties	Y	Y
.2	Running difficulties	Y	Y
.3	Importance of replacement shear pins	Y	Y
.4	Servicing and maintenance:		
.1	Inspection procedures		Y
.2	Carburettor maintenance		Y
.3	Engine mounting		Y
.4	Procedures for lay up or storage.		Y
2.11 General			
The candidate should have knowledge in the following:			
.1	Dry-docking and slipping basics		Y
.2	Basic Seamanship	Y	Y
.1	Basic rope-work	Y	Y
.2	Mooring/unmooring and anchoring	Y	Y
.3	Ship Knowledge – common terms	Y	Y
.1	Types of ships	Y	Y
.2	Parts of ships	Y	Y
.4	Engine Room Layouts	Y	Y
.5	Basic security issues	Y	Y

Annex 12***PREVENTION OF POLLUTION BY GARBAGE FROM SHIPS
(MARPOL ANNEX V)*****PART A – INTRODUCTION**

1 On 1 January 2013 the amendments to MARPOL Annex V relating to the prevention of pollution by garbage from ships came into effect.

2 The new amendments prohibit the disposal of almost all kinds of garbage at sea with the exemption under specific requirements of food waste, animal carcasses, cargo residues contained in wash water and environmental friendly cleaning agents. For a simplified overview of the new discharge provisions see the attached schedule.

3 According to the revised MARPOL Annex V shipboard generated garbage is to be grouped in nine categories, which are to be used for record purposes in the Garbage Record Book. The superseded MARPOL Annex V defined only six categories.

The nine categories¹⁴ of shipboard generated garbage are:

- A. Plastics
- B. Food wastes
- C. Domestic Wastes
- D. Cooking Oil
- E. Incinerator ashes
- F. Operational wastes
- G. Cargo residues
- H. Animal Carcasses
- I. Fishing Gear

¹⁴For more information:

- 1. Resolution MEPC.201(62): Amendmentsto the annex of the protocol of 1978 relating to the international convention for the prevention of pollution from ships, 1973(Revised MARPOL Annex V).
- 2. Resolution MEPC.219(63): Guidelines for the implementation of MARPOL Annex V.
- 3. Resolution MEPC.220(63): 2012 Guidelines for the development of garbage management plans.

***Simplified overview of the discharge provisions of the revised
MARPOL Annex V (resolution MEPC.201(62)) which
entered into force on 1 January 2013***

(for the full text of the respective discharge requirements please refer to the text of the revised
MARPOL Annex V, and for more detailed guidance please consult the
2012 Guidelines for the implementation of MARPOL Annex V (resolution MEPC.219(63))

Type of garbage	Ships outside special areas	Ships within special areas	Offshore platforms and all ships within 500 m of such platforms
Food waste comminuted or ground	Discharge permitted ≥ 3 nm from the nearest land and <i>en route</i>	Discharge permitted ≥ 12 nm from the nearest land and <i>en route</i>	Discharge permitted ≥ 12 nm from the nearest land
Food waste not comminuted or ground	Discharge permitted ≥ 12 nm from the nearest land and <i>en route</i>	Discharge prohibited	Discharge prohibited
Cargo residues ¹⁵ not contained in wash water	Discharge permitted ≥ 12 nm from the nearest land and <i>en route</i>	Discharge prohibited	Discharge prohibited
Cargo residues contained in wash water		Discharge only permitted in specific circumstances ¹⁶ and ≥ 12 nm from the nearest land and <i>en route</i>	Discharge prohibited
Cleaning agents and additives contained in cargo hold washwater	Discharge permitted	Discharge only permitted in specific circumstances ² and ≥ 12 nm from the nearest land and <i>en route</i>	Discharge prohibited
Cleaning agents and additives contained in deck and external surfaces wash water		Discharge permitted	Discharge prohibited
Carcasses of animals carried on board as cargo and which died during the voyage	Discharge permitted as far from the nearest land as possible and <i>en route</i>	Discharge prohibited	Discharge prohibited
All other garbage including plastics, domestic wastes, cooking oil incinerator ashes, operational wastes and fishing gear	Discharge prohibited	Discharge prohibited	Discharge prohibited
Mixed garbage	When garbage is mixed with or contaminated by other substances prohibited from discharge or having different discharge requirements, the more stringent requirements shall apply		

¹⁵These substances must not be harmful to the marine environment.

¹⁶According to regulation 6.1.2 of MARPOL Annex V, the discharge shall only be allowed if: (a) both the port of departure and the next port of destination are within the special area and the ship will not transit outside the special area between these ports (regulation 6.1.2.3); and (b) if no adequate reception facilities are available at those ports (regulation 6.1.2.3).

SAMPLE GARBAGE MANAGEMENT PLAN

Name of vessel	<input type="text" value="Insert name of vessel"/>
Official number	<input type="text" value="Insert official number"/>
Call sign	<input type="text" value="Insert call sign"/>
Classification Society (if applicable)	<input type="text" value="Insert name of Classification Society"/>
Port of registry	<input type="text" value="Insert port of registry"/>
Date plan due for review	<input type="text" value="Insert date plan due for review"/>
Responsible person*	<input type="text" value="Insert name of responsible person"/>

**For small vessels with one or minimum seafarers it will be the responsibility of the owner/operator to determine who will be responsible for carrying out the plan and implementing the procedures within the plan.*

Regulation 10(2) of Annex V of MARPOL provides as follows:

“Every ship of 100 gross tonnage and above, and every ship which is certified to carry 15 or more persons, and fixed or floating platforms shall carry a Garbage Management Plan which the seafarer shall follow. This plan shall provide written procedures for minimizing, collecting, storing, processing and disposing of garbage, including the use of the equipment on board. It shall also designate the persons in charge of carrying out the plan. Such a plan shall be based on the guidelines developed by the Organization and written in the working language by the seafarers.”

Garbage means all kinds of food wastes, domestic wastes and operational wastes, all plastics, cargoes residues, incinerator ashes, cooking oil, fishing gear, and animal carcasses generated during the normal operation of the ship and liable to be disposed of continuously or periodically except those substances which are defined or listed in other Annexes to the present Convention.

Garbage does not include fresh fish and parts thereof generated as a result of fishing activities undertaken during the voyage, or as a result of aquaculture activities which involve the transport of fish including shellfish for placement in the aquaculture facility and the transport of harvested fish including shellfish from such facilities to shore for processing.

PROCEDURES FOR COLLECTING GARBAGE

This section should identify suitable containers and location for collection and separation.

For larger vessels, include description of the process for transporting garbage from where it is generated to the collection and separation points.

Needs of on shore garbage reception facilities, taking into account possible:

1. local recycling arrangements;
2. intended on-board processing; and
3. intended storage.

Bins will be placed on vessel for recyclable items and for general waste.

Each bin will be clearly labelled and will be lined with bin liners for ease of disposal and to ensure that liquids are contained. Bins will also be securely fastened to ensure that they do not move or open and release while at sea.

Food waste that is likely to decompose (such as meat, prawn tails, etc.) will be double bagged and frozen ready to be disposed of at shore garbage facilities.

Bins will be on wheels so that garbage can be wheeled off vessel at port. In instances where only small amounts of garbage are collected, bags will be tied up and carried off the vessel.

No garbage will be disposed of at sea, as vessel does not go further than 12 nautical miles from the nearest land.

Procedures for processing garbage

This section only applies to vessels fitted with processing equipment. If this does not apply to you insert 'N/A'.

For vessels fitted with equipment to process garbage, this section should:

1. describe how garbage will be handled between primary processing locations and the storage or disposal locations, as well as describing the processing procedures used; and
2. describe the processing procedure used for disposal at sea (in accordance with MARPOL Annex V).

No processing equipment carried on vessel.

All garbage will be disposed of using shore based facilities.

Procedures for storing garbage

This section should:

1. identify the location, the intended use, and the capacity of available storage points for each category of garbage; and

2. explain how bins are fastened to ensure that they do not move or open and release while at sea.

Bins will be placed at each end of vessel when transporting passengers.

Bins will also be securely fastened to ensure that they do not move or open and release while at sea.

Depending on size and weight of the garbage, bins will either be wheeled or carried off the vessel ensuring bin liner is replaced as soon as empty bin is returned to the vessel. Food waste will be disposed of on a daily basis.

All seafarers are familiar with garbage management procedures and any procedure be will be included in induction for new staff members.

Procedures for disposing of garbage

Describe the vessel's procedures to ensure compliance with the requirements of Regulation 8 Annex V of MARPOL for disposal of garbage, e.g. shore based facilities.

All garbage will be disposed of using shore based facilities.

In situations where shore based facilities are not available, adequate on board storage space will be allocated to ensure that garbage may be appropriately managed until suitable shore based facilities are available.

FORM OF GARBAGE RECORD BOOK

Name of ship: _____

Distinctive number or letters: _____

IMO No.: _____

Period: _____ From: _____ To: _____

1 Introduction

In accordance with regulation 10 of Annex V of the International Convention for the Prevention of Pollution from Ships, 1973, as modified by the Protocol of 1978 (MARPOL), a record is to be kept of each discharge operation or completed incineration. This includes discharges into the sea, to reception facilities, or to other ships, as well as the accidental loss of garbage.

2 Garbage and garbage management

Garbage means all kinds of food wastes, domestic wastes and operational wastes, all Garbage does not include fresh fish and parts thereof generated as a result of fishing activities undertaken during the voyage, or as a result of aquaculture activities which involve the transport of fish including shellfish for placement in the aquaculture facility and the transport of harvested fish including shellfish from such facilities to shore for processing. The Guidelines for the Implementation of Annex V of MARPOL¹⁷ should also be referred to for relevant information.

3 Description of the garbage

Garbage is to be grouped into categories for the purposes of the Garbage Record Book (or ship's official log-book) as follows:

- A Plastics
- B Food wastes
- C Domestic Wastes
- D Cooking Oil
- E Incinerator ashes
- F Operational wastes
- G Cargo residues
- H Animal Carcass(es)
- I Fishing Gear¹⁸

¹⁷ Refer to the Guidelines for the Implementation of Annex V of MARPOL 73/78, as amended by resolutions.

¹⁸ Refer to Guidelines to be developed by the Organization.

4 Entries in the Garbage Record Book

Entries in the Garbage Record Book shall be made on each of the following occasions:

- .1 When garbage is discharged to a reception facility¹⁹ ashore or to other ships:
 - .1 Date and time of discharge
 - .2 Port or facility, or name of ship
 - .3 Categories of garbage discharged
 - .4 Estimated amount discharged for each category in cubic metres
 - .5 Signature of officer in charge of the operation.
- .2 When garbage is incinerated:
 - .1 Date and time of start and stop of incineration
 - .2 Position of the ship (latitude and longitude) at the start and stop of incineration
 - .3 Categories of garbage incinerated
 - .4 Estimated amount incinerated in cubic metres
 - .5 Signature of the officer in charge of the operation.
- .3 When garbage is discharged into the sea in accordance with regulations 4, 5 or 6 of Annex V of MARPOL:
 - .1 Date and time of discharge
 - .2 Position of the ship (latitude and longitude). Note: for cargo residue discharges, include discharge start and stop positions.
 - .3 Category of garbage discharged
 - .4 Estimated amount discharged for each category in cubic metres
 - .5 Signature of the officer in charge of the operation.
- .4 Accidental or other exceptional discharges or loss of garbage into the sea, including in accordance with regulation 7 of Annex V of MARPOL:
 - .1 Date and time of occurrence
 - .2 Port or position of the ship at time of occurrence (latitude, longitude and water depth if known)

¹⁹ Ship's masters should obtain from the operator of the reception facilities, which includes barges and trucks, a receipt or certificate specifying the estimated amount of garbage transferred. The receipts or certificates must be kept together with the Garbage Record Book.

- .3 Categories of garbage discharged or lost
- .4 Estimated amount for each category in cubic metres
- .5 The reason for the discharge or loss and general remarks.

5 Amount of garbage

The amount of garbage on board should be estimated in cubic metres, if possible separately according to category. The Garbage Record Book contains many references to estimated amount of garbage. It is recognized that the accuracy of estimating amounts of garbage is left to interpretation. Volume estimates will differ before and after processing. Some processing procedures may not allow for a usable estimate of volume, e.g. the continuous processing of food waste. Such factors should be taken into consideration when making and interpreting entries made in a record.

RECORD OF GARBAGE DISCHARGES

Ship's name: _____

Distinctive No., or letters: _____

IMO No.: _____

Garbage categories:

- A Plastics
- B Food wastes
- C Domestic wastes (e.g., paper products, rags, glass, metal, bottles, crockery, etc.)
- D Cooking oil
- E Incinerator Ashes
- F Operational wastes
- G Cargo residues
- H Animal Carcass(es)
- I Fishing gear

Date/Time**Position of the Ship/Remarks (e.g. accidental loss)****Category****Estimated Amount Discharged or Incinerated****To Sea****To Reception Facility****Incineration****Certification/ Signature**

SAMPLE PLACARD**INTERNATIONAL POLLUTION REGULATIONS
MARPOL CONVENTION, ANNEX V****DISCHARGE OF GARBAGE INTO THE SEA IS
PROHIBITED**

All garbage should be retained on board and disposed at facilities on land, in port or marina.

Food waste can be legally discharged at sea provided the vessel is moving and is more than 12 nautical miles from the nearest land. Such Food wastes shall be comminuted or ground and shall be capable of passing through a screen with openings no greater than 25 mm.

For vessels of 100 gross tonnage and above, refer to the Garbage Management Plan.

Fishing and tourist vessels are allowed to release small amounts of food into the sea for the purpose of fish feeding or tourist operations.

Note: Cooking oil is not considered food waste and cannot be discharged into the sea.

Violations of these requirements may result in penalties.

REPORTING ILLEGAL GARBAGE DISCHARGE

You can help keep our seas clean by reporting any violations of the garbage discharge regulations.

Information is needed to assist in investigating and prosecuting offenders. Useful information includes:

- the name of the vessel responsible;
- the time, date and location of the incident (distance from land, GPS coordinates);
- details of how much and what type of garbage was discharged; and
- other witnesses or vessels in the vicinity.

If possible take photographs or video images of the pollution, the vessel or the person involved.

Please REPORT illegal garbage discharges to:

Please keep this information card on board your vessel.

MARPOL requires that all vessels of 12 m or more in length overall display a placard that notifies the seafarer and passengers of the garbage discharge regulations.

Annex 13

DETERMINATION OF LENGTH

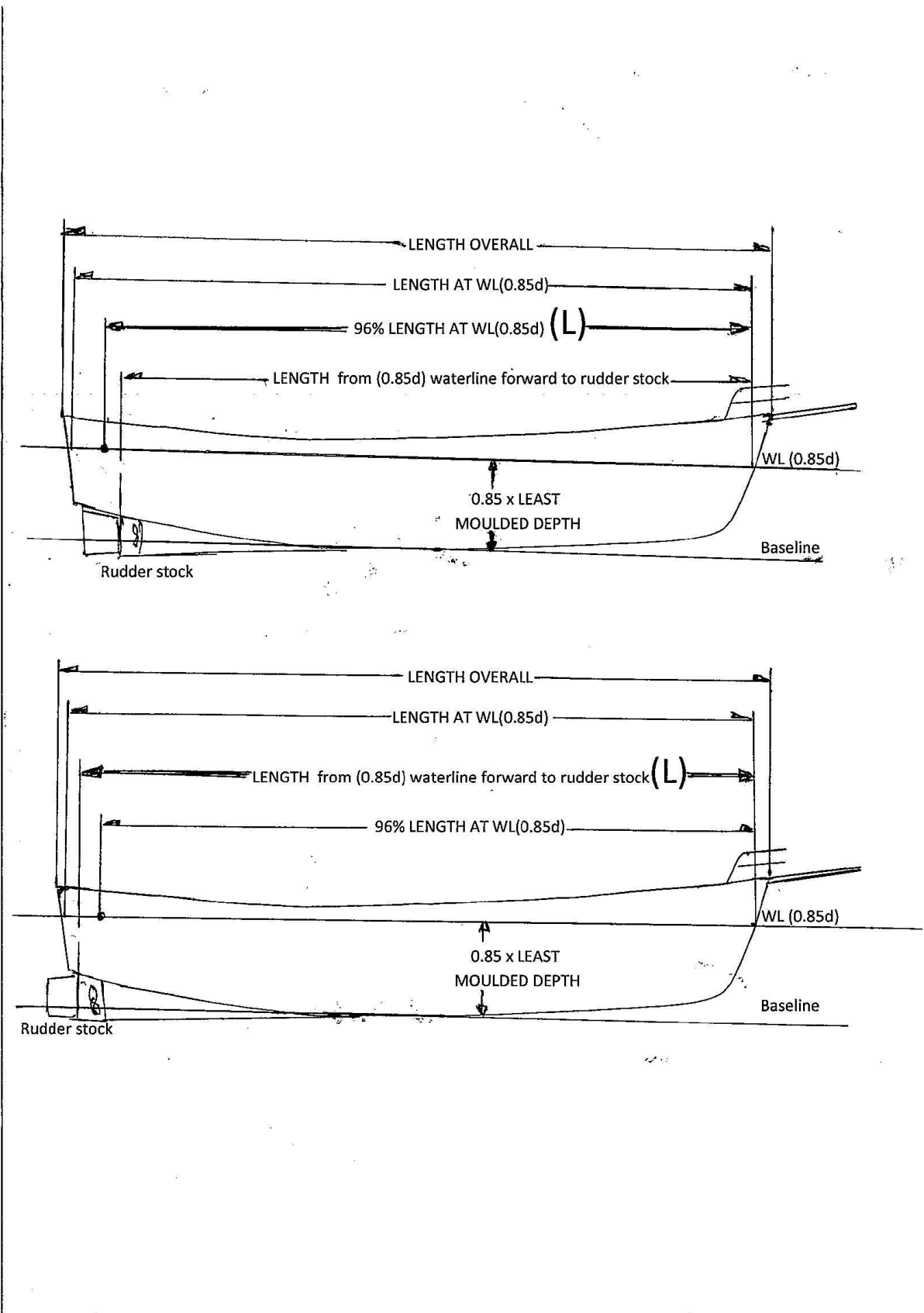

Annex 14

ACCOMMODATION AND RECREATIONAL FACILITIES EQUIVALENT STANDARDS

For vessels keel laid or major conversion commenced on and after 1 July 2018

1 Equivalent arrangements

1.1 The purpose of this section is to implement equivalent arrangements to the crew accommodation requirements of SCV Code vessels. The equivalent standards shall be applied to all vessels with a keel laid down on and after 1 July 2018. The standards of accommodation and recreational facilities are applied to vessels where appropriate, taking into consideration the length of the voyage(s), over-night voyage(s), number of days at sea, etc.

1.2 Accommodation shall provide decent living conditions and recreational facilities for those persons employed or engaged in any work capacity onboard.

1.3 In order to provide decent living conditions and recreational facilities the following requirements are the minimum standards:

- .1** The materials used to construct internal bulkheads, panelling and sheeting, floors and joinings shall be suitable for the purpose and conducive to ensuring a healthy environment.
- .2** Excessive noise and vibration shall be limited within accommodation spaces, and as far as practicable in accordance with relevant international standards. Where the seafarers' exposure to noise and vibration is very time limited in accommodation spaces, alternative arrangements may be accepted.

2 Access/Escape arrangements

2.1 SCV vessels shall comply with the escape arrangements in chapter **II/4**.

3 Headroom

3.1 There shall be adequate and reasonable headroom for all seafarers on board taking into consideration the size and operation of vessel. Headroom provided should not result in discomfort to the seafarers onboard.

3.2 For spaces where seafarers are expected to stand for prolonged periods, the minimum headroom should be 190 cm. The Administration may allow reduced height in some locations if it does not result in discomfort to seafarers.

4 Ventilation

4.1 An effective means of ventilation shall be provided to all enclosed spaces which are entered by personnel.

4.2 Mechanical ventilation shall be provided to all accommodation spaces. As a minimum, mechanical ventilation shall be capable of providing 6 changes of air per hour, when all access and other openings (other than ventilation intakes) to the spaces are closed.

4.3 In spaces where sanitary facilities are provided there shall be ventilation that draws from the accommodation and extracts to the open air independent of the other parts of the accommodation.

5 Lighting

5.1 An electric lighting system shall be installed which is capable of supplying adequate light to all enclosed accommodation and working spaces.

5.2 Seafarer's sleeping rooms and mess rooms shall be lit by natural light and provided with adequate artificial light. Where the provision of natural light is impracticable, adequate artificial light may be acceptable in limited areas.

6 Water services and provision

6.1 Hot and cold running fresh water shall be available in all wash places.

6.2 An adequate supply of fresh drinking water shall be provided and piped to convenient positions throughout the accommodation spaces.

6.3 An emergency reserve supply of drinking water shall be carried sufficient to provide at least 2 litres of water per person.

7 Galley facilities and provision of food

7.1 Where applicable adequate food shall be provided, free of charge for all seafarers. The provision of food shall take account of seafarers' religious requirements and cultural practices, the nature and duration of the voyage and shall be suitable in respect of quantity, nutritional value, quality and variety.

7.2 The organization and equipment of the galley shall be such as to permit the provision of adequate, varied and nutritious meals to the seafarers that are prepared and served in hygienic conditions.

7.3 This shall include, as a minimum, that the galley is fitted with a means of cooking, a sink and have adequate working surface(s) for the preparation of food. The galley floor shall be provided with a non-slip surface and provide a good foothold.

7.4 All furniture and fittings in the galley shall be made of a material which is impervious to dirt and moisture. All metal parts of furniture and fittings shall be rust resistant.

7.5 Ventilation in the galley shall be arranged to ensure that there is an adequate supply of fresh air and the efficient discharge of fumes into the open air.

7.6 When a cooking appliance is gimballed it shall be protected by a crash bar or other means to prevent personal injury. Means shall be provided to lock the gimbaling mechanism.

7.7 Means shall be provided to allow the cook to be secured in position, with both hands free for working, when the vessel motion threatens safe working.

7.8 Secure and hygienic storage for food and garbage shall be provided.

8 Hand Holds and Grab Rails

8.1 There shall be sufficient hand holds and grab rails within the accommodation to allow safe movement around the accommodation at all times. Stairways shall be specially considered.

9 Sleeping accommodation

9.1 When sleeping accommodation on board is required it shall be of adequate size and properly equipped so as to ensure reasonable comfort and facilitate tidiness.

9.2 Wherever possible there shall be no direct access into sleeping rooms from spaces for machinery, galleys, storerooms, drying rooms, or communal sanitary areas.

9.3 If seafarer sleeping rooms are situated next to any such space, the sleeping room and the other space shall have a bulkhead between them with a door that may be locked.

9.4 In seafarer accommodation, wherever possible, the maximum number of seafarers per sleeping room is to be two and there shall be unobstructed access to at least one side of each bed. Any increase in the maximum number of persons per sleeping room shall be agreed with the Administration.

9.5 Sleeping accommodation shall be situated or equipped, as practicable, so as to provide appropriate levels of privacy for men and for women.

9.6 Berths for seafarers must have a minimum inside dimension of either:

- .1** not less than 190 cm by 70 cm with no tapering where it is satisfied that this is reasonable and will not result in discomfort to the seafarers; or
- .2** not less than 198 cm in length and not less than 80 cm in width over half the length of the berth. A taper is permitted from half the length of the berth towards the foot of the berth but under no circumstances is the berth permitted to be narrower than 50 cm at any point.

9.7 Where considered appropriate, means for preventing the occupants from falling out of the berth shall be provided.

9.8 Except as permitted in **9.9**, sleeping rooms shall be situated above the load line/freeboard mark amidships or aft but in no case forward of the collision bulkhead.

9.9 Where it is not possible to provide sleeping accommodation above the load line/freeboard mark as required by **9.8**, there shall be an alarm fitted to provide early warning of flooding that alerts occupants of the sleeping accommodation and provide them with sufficient time to escape from the accommodation.

9.10 There shall be no mixed gender seafarer cabins. Seafarer cabins must be designed and will only be approved as twin cabins, not as double cabins. There must not be any compulsion in any way whatsoever for seafarers of opposite gender to share a cabin.

10 Sanitary facilities

10.1 For each 6 seafarers onboard there must be at least one set of sanitary facilities separated from the rest of the accommodation.

10.2 Each set of sanitary facilities shall include one shower or one wash basin and one toilet. Each set of sanitary facilities must be provided with a door that is lockable.

10.3 Where reasonable and practicable there shall be separate sanitary facilities provided for men and women.

10.4 In vessels where a sanitary system, including a holding tank, is provided, care shall be taken to ensure that there is no possibility of fumes from the tank finding their way back to a toilet, in the event that the water seal at the toilet may be broken.

11 Mess rooms

11.1 Mess rooms shall be of adequate size and comfort, properly furnished and equipped, including ongoing facilities for refreshment, taking account of the greatest number of seafarers likely to use them at any one time.

11.2 Should the mess be a shared facility for seafarers and passengers, this shall be subject to agreement by the Owner and the flag Administration.

12 Recreational facilities

12.1 Appropriate seafarers' recreational facilities and amenities must be provided, where applicable, to the satisfaction of the flag Administration.

12.2 All vessels shall have a space or spaces on open deck to which the seafarers can have safe access and use when off duty.

12.3 Such spaces must be of adequate area and protected from the elements having regard to the size of the vessel and the number of seafarers onboard. Due consideration shall be given to any areas of use which may be considered as posing a safety risk to seafarers.

13 Stowage facilities for personal effects

13.1 Each seafarer shall be provided with adequate storage space for personal effects which must be a minimum of 0.125 cubic metres per seafarer.

14 Machinery space boundaries

14.1 Where machinery spaces are adjacent to accommodation spaces, the boundaries shall be designed to be gas tight. The requirement to be gas-tight is taken to mean that bulkheads shall be so constructed as to prevent ingress of water and noxious gases into adjacent cabins as far as is reasonable and practicable to so do.

14.2 Machinery space boundaries must retain any liquids which may leak from the equipment within the machinery space.

15 Securing of heavy equipment

15.1 All heavy items of equipment such as ballast, batteries, cooking stove, etc, shall be securely fastened in place. All stowage lockers containing heavy items shall have lids or doors which are capable of being securely fastened.

16 Master's inspections

16.1 There shall be weekly documented inspections carried out on board vessels certified to operate in coastal and exposed waters, by or under the authority of the Master, with respect to:

- .1 supplies of food and drinking water;
- .2 all spaces and equipment used for the storage and handling of food and drinking water;
- .3 galley and other equipment used for the preparation and service of meals; and
- .4 that seafarer accommodation is clean, decently habitable and maintained in a good state of repair.

16.2 The results of each inspection shall be recorded and made available for review.

Annex 15 A

[Name of the Flag Administration]

Logo of the Flag
Administration**MLC 2006 - EQUIVALENT STANDARDS for SCV Code vessels as approved by the Administration****Inspection Report for SCV Code Vessels keel laid before 1 July 2018****1. Ship's particulars**

1.1. Name of ship: _____ 1.2 Distinctive number or letters: _____

1.3 Port of Registry: _____ 1.4 Gross tonnage: _____

1.5 IMO number: _____ 1.6 Type of ship: _____

1.7 Keel laid date: _____

1.8 Name and address of ship owner: _____

1.9 Location of inspection: _____

1.10 Maximum number of seafarers accommodated on-board: _____

2. Inspection type (please tick as appropriate) Interim Initial Intermediate Renewal Additional**3. Mandatory Inspection Items**

(Guidance is provided in italics)

3.1 Minimum age	Yes
3.1.1 The shipowner has a system in place to verify that seafarers on-board are 16 years of age or over. <i>(Minimum age) No person below the age of 16 years shall be employed, engaged or work on the vessel. A young seafarer is defined as a seafarer under the age of 18.</i>	
3.1.2 Seafarers under 18 years are not allowed to work at night <i>Hours of rest. There is a prohibition on young seafarers working at night, which as a minimum must include a period of at least 9 hours starting no later than midnight and ending no earlier than 0500 hours. However a seafarer aged 16 or 17 may work at night if the work forms part of an established training program. Health and safety protection and accident prevention Measures shall be put in place to protect young seafarers from carrying out any work which is likely to jeopardize their health and safety.</i>	Yes / NA

3.2 Medical certification	Yes
3.2.1 All the seafarers have a valid medical fitness certificate	
3.2.2 The company has a system for ensuring that the seafarers it employs have suitable and valid medical fitness certificates	

3.3 Qualifications of seafarers	Yes
3.3.1 The company has a system for ensuring that the seafarers it employs are correctly qualified for the voyages they undertake.	
3.3.2 The company provides familiarisation training for its seafarers.	

3.4 Seafarers' Employment Agreements (SEA)	Yes / NA*
3.4.1 The SEA complies with the minimum standards. <i>(Seafarer Employment Agreements) requires that ship owners and all seafarers they employ have a signed original SEA meeting the minimum requirements as laid down in SCV Code chapter IX part D</i>	
3.4.2 All seafarers on-board have an SEA.	
3.4.3 The company has a system for ensuring all seafarers it employs have an SEA.	

*N/A where the ship owner is the sole seafarer on-board.

3.5 Hours of rest	Yes
3.5.1 The records of hours of rest are kept and signed by the crew and master.	
3.5.2 The standards for minimum hours of rest are being complied with. <i>The minimum limits on hours of rest provided by the ship owner shall be 10 hours in any 24 hour period, which may be divided into no more than two (2) periods – one of which shall be at least six (6) hours in length, and no more than 14 hours between any consecutive periods; and 77 hours in any seven day period.</i>	

3.6 Manning levels for the vessel	Yes / NA*
3.6.1 Manning levels are compliant with the minimum safe manning requirements as mentioned on the SCV certificate.	
3.6.2 There is a procedure for briefing a second person on assisting the master.	
3.6.3 The company has a system for ensuring that there are sufficient seafarers / persons, as required by the administration, on board the vessel.	

* NA where there is no second person on board to assist the master.

3.7 Accommodation	Yes/ NA
The accommodation of the SCV vessels with keel laid date before 1 July 2018 shall be in accordance with chapter IX Part A of the SCV Code.	
3.7.1 Access/Escape arrangements	
3.7.2 Ventilation	
3.7.3 Lighting	
3.7.4 Water services and provision	
3.7.5 Hand holds and grab rails	
3.7.6 Sleeping accommodation	
3.7.7 Sanitary facilities	
3.7.8 Stowage facilities for personal effects	
3.7.9 Machinery space boundaries	
3.7.10 Securing of heavy equipment	
3.7.11 Protection from mosquitoes	

3.8 Food and catering	Yes / NA
3.8.1 The shipowner has a system in place to verify that adequate food is provided for all seafarers free of charge. <i>Food and catering requires that food is supplied free of charge to seafarers and is suitable in terms of quality, nutritional value, quality, variety and seafarers cultural and religious needs</i>	
3.8.2 There is adequate ventilation in the galley and a supply of fresh air to discharge fumes to the open air.	
3.8.3 Gimballed cooking appliances have a crash bar and there is a means of locking the gimbal.	
3.8.4 There are secure and hygienic storage facilities for food and garbage.	
3.8.5 The company has a system for ensuring that there is a person, 18 years and over in age, with accepted food hygiene training to supervise the preparation and cooking of food for seafarers on-board the vessel.	

3.9 Health and safety and accident prevention	Yes / NA
3.9.1 There are written risk assessments, or the inspector is satisfied that crew have demonstrated that they are aware of the risks verbally.	
3.9.2 There are no obvious health and safety problems. <i>The ship-owner shall ensure as far as practicable, the health and safety of seafarers on-board the ship. In carrying out this duty the ship owner shall ensure reasonable precautions are taken to prevent occupational accidents, injuries and diseases on-board ship.</i>	
3.9.3 Complaints from seafarers are being suitably dealt with.	
3.9.4 Where there are 5 or more crew members there is a designated safety official on board.	

3.10 On-board medical care	Yes
3.10.1 Medical stores are in accordance with Annex 8 of the SCV Code.	
3.10.2 There is a person on-board with adequate first aid training.	
3.10.3 The company has a system for ensuring that there is a person with first aid training on-board the vessel.	
3.10.4 Seafarers have access to medical care ashore when overseas. <i>Medical care on-board and ashore requires that the cost of medical and dental treatment for seafarers is borne by the ship owner. Seafarers have the right to visit a qualified medical doctor or dentist without delay in ports of call, where practicable.</i>	

3.11 On-board complaint procedures	Yes / NA*
3.11.1 There is a complaints procedure posted up which is available to seafarers. <i>The on-board complaints procedure requires that ship owners must ensure their ships have on board procedures for the fair, effective and expeditious handling of seafarer complaints. Seafarers must not be victimised for raising complaints and have the right to be accompanied or represented.</i>	
3.11.2 The complaints procedure includes details of who to contact in the Flag Administration if the complaint is not resolved. <i>The complaints procedure must allow for complaints directly to the Master and to the</i>	

<i>Flag Administration if the complaint is not resolved.</i>	
3.11.3 Where complaints have been recorded have they been resolved*	

* NA Where the ship owner is the sole seafarer on-board or where there are no complaints received.

3.12 Payment of wages	Yes / NA*
3.12.1 Payment of wages is in accordance with the SEA. <i>Payment of wages defines the principles applying to the payment and calculation of basic pay and wages which are partially or fully consolidated.</i>	
3.12.2 Payment of wages is at least monthly. <i>All seafarers shall receive a monthly account of their wages.</i>	
3.12.3 Where possible, seafarers confirm that their wages are being paid in accordance with the SEA	

* NA where the ship owner is the sole seafarer on-board.

3.13 Financial security	Yes / NA*
3.13.1 Evidence of financial security to cover abandonment of a seafarer.	
3.13.2 Evidence of financial security to cover death or long term disability due to an occupational injury, illness or hazard	

* NA where the ship owner is the sole seafarer on-board.

4. Declarations

Shipowner's declaration:

I declare that I will continue to comply with the requirements of the SCV Code chapter IX, Annex 15 A and 16 for the validity of this inspection report.

Ship owner name:

Name of signatory of the ship owner: Signed:

Date:

Inspector's declaration

I declare that I have reviewed the above measures, and, following inspection of the ship, and I have determined that they meet the purposes set out in the SCV code Chapter-IX and Annex 15 A and 16.

Inspector name:

Signed:



Of [insert name of Certifying Authority] authorised by the [name of the Flag Administration]
Date of Inspection:..... This Inspection Report is valid
until.....
(maximum of 3 years from date of inspection date)

This report is to be retained onboard for a period of 3 years and must be made available for consultation by [name of the Flag Administration] and Port State Control officers at all times

Annex 15 B

[Name of the Flag Administration]

Logo of the Flag
Administration**MLC 2006 - EQUIVALENT STANDARDS for SCV Code vessels as approved by the Administration****Inspection Report for SCV Code Vessels keel laid on or after 1 July 2018****1. Ship's particulars**

1.1. Name of ship: _____ 1.2 Distinctive number or letters: _____

1.3 Port of Registry: _____ 1.4 Gross tonnage: _____

1.5 IMO number: _____ 1.6 Type of ship: _____

1.7 Keel laid date: _____

1.8 Name and address of ship owner: _____

1.9 Location of inspection: _____

1.10 Maximum number of seafarers accommodated on-board: _____

2. Inspection type (please tick as appropriate) Interim Initial Intermediate Renewal Additional**3. Mandatory Inspection Items**

(Guidance is provided in italics)

3.1 Minimum age	Yes
3.1.1 The shipowner has a system in place to verify that seafarers on-board are 16 years of age or over. <i>Minimum age. No person below the age of 16 years shall be employed, engaged or work on the vessel. A young seafarer is defined as a seafarer under the age of 18.</i>	
3.1.2 Seafarers under 18 years are not allowed to work at night.	Yes / NA
<i>Hours of rest. There is a prohibition on young seafarers working at night, which as a minimum must include a period of at least 9 hours starting no later than midnight and ending no earlier than 0500 hours. However, a seafarer aged 16 or 17 may work at night if the work forms part of an established training program.</i> <i>Health and safety protection and accident prevention) Measures shall be put in place to protect young seafarers from carrying out any work which is likely to jeopardize their health and safety.</i>	

3.2 Medical certification	Yes
3.2.1 All the seafarers have a valid medical fitness certificate.	
3.2.2 The company has a system for ensuring that the seafarers it employs have suitable and valid medical fitness certificates.	

3.3 Qualifications of seafarers	Yes
3.3.1 The company has a system for ensuring that the seafarers it employs are correctly qualified for the voyages they undertake.	
3.3.2 The company provides familiarization training for its seafarers.	

3.4 Seafarers' Employment Agreements (SEA)	Yes / NA*
3.4.1 The SEA complies with the minimum standards. <i>Seafarer Employment Agreements require that ship owners and all seafarers they employ have a signed original SEA meeting the minimum requirements as laid down in SCV code Chapter IX part D.</i>	
3.4.2 All seafarers on-board have an SEA.	
3.4.3 The company has a system for ensuring all seafarers it employs have an SEA.	

*N/A where the ship owner is the sole seafarer on-board.

3.5 Hours of rest	Yes
3.5.1 The records of hours of rest are kept and signed by the crew and master.	
3.5.2 The standards for minimum hours of rest are being complied with. <i>The minimum limits on hours of rest provided by the ship owner shall be 10 hours in any 24-hour period, which may be divided into no more than two (2) periods – one of which shall be at least six (6) hours in length, and no more than 14 hours between any consecutive periods; and 77 hours in any seven-day period.</i>	

3.6 Manning levels for the vessel	Yes / NA*
3.6.1 Manning levels are compliant with the minimum safe manning requirements as mentioned on the SCV certificate.	
3.6.2 There is a procedure for briefing a second person on assisting the master.	
3.6.3 The company has a system for ensuring that there are sufficient seafarers/persons, as required by the administration, onboard the vessel.	

* NA where there is no second person on board to assist the master.

3.7 Accommodation	Yes / NA
The accommodation of the SCV vessels with keel laid date on or after 1 July 2018 should be in accordance with Annex 14 of the SCV Code.	
3.7.1 Access/Escape arrangements	
3.7.2 Headroom	
3.7.3 Ventilation	
3.7.4 Lighting	
3.7.5 Water services and provision	
3.7.6 Hand holds and grab rails	
3.7.7 Sleeping accommodation	
3.7.8 Sanitary facilities	
3.7.9 Mess rooms	
3.7.10 Stowage facilities for personal effects	

3.7.11 Machinery space boundaries	
3.7.12 Securing of heavy equipment	
3.7.13 Protection from mosquitoes	
3.7.14 Master's inspection	

3.8 On-board recreational facilities	Yes / NA
3.8.1 Recreational facilities are provided on-board. <i>Ship owners to provide appropriate seafarers' recreational facilities, amenities and services, as adapted to meet the special needs of seafarers who must live and work on ships. Examples of recreational facilities include reading and writing facilities and, where practicable, games.</i>	
3.8.2 There is an open deck space provided, with safe access that protects seafarers from the elements during any rest period.	

3.9 Food and catering	Yes / NA
3.9.1 The shipowner has a system in place to verify that adequate food is provided for all seafarers free of charge. <i>Food and catering requires that food is supplied free of charge to seafarers and is suitable in terms of quality, nutritional value, quality, variety and seafarers cultural and religious needs</i>	
3.9.2 The catering facilities on-board are fitted with a sink, a means of cooking and adequate working surface for the preparation of food. The floor surface in the galley area is non-slip. The facilities are hygienic.	
3.9.3 The furniture and fittings in the galley are made of a material which is impervious to dirt and moisture. Metal parts are rust resistant.	
3.9.4 There is adequate ventilation in the galley and a supply of fresh air to discharge fumes to the open air.	
3.9.5 Gimballed cooking appliances have a crash bar and there is a means of locking the gimbal.	
3.9.6 Means shall be provided to allow the cook to be secured in position with both hands free for working, when the vessel motions threaten safe working.	
3.9.7 There are secure and hygienic storage facilities for food and garbage.	
3.9.8 There is a messing area provided which accommodates the greatest number of people likely to be messing at one time.	
3.9.9 The company has a system for ensuring that there is somebody, > 18 years in age, with accepted food hygiene training to supervise the preparation and cooking of food for seafarers on-board the vessel	

3.10 Health and safety and accident prevention	Yes / NA
3.10.1 There are written risk assessments, or the inspector is satisfied that crew have demonstrated that they are aware of the risks verbally.	
3.10.2 There are no obvious health and safety problems. <i>The ship owner shall ensure as far as practicable, the health and safety of seafarers on-board the ship. In carrying out this duty the ship owner shall ensure reasonable precautions are taken to prevent occupational accidents, injuries and diseases on-board ship.</i>	
3.10.3 Complaints from seafarers are being suitably dealt with.	
3.10.4 Where there are 5 or more crew members there is a designated safety official onboard.	

3.11 On-board medical care	Yes
3.11.1 Medical stores are in accordance with Annex 8 of the SCV Code	
3.11.2 There is somebody on-board with adequate first aid training.	
3.11.3 The company has a system for ensuring that there is somebody with first aid training on-board the vessel.	
3.11.4 Seafarers have access to medical care ashore overseas. <i>Medical care on-board and ashore requires that the cost of medical and dental treatment for seafarers is borne by the ship owner. Seafarers have the right to visit a qualified medical doctor or dentist without delay in ports of call, where practicable.</i>	

3.12 On-board complaint procedures	Yes / NA*
3.12.1 There is a complaints procedure posted up which is available to seafarers. <i>The on-board complaints procedure requires that shipowners must ensure their ships have onboard procedures for the fair, effective and expeditious handling of seafarer complaints. Seafarers must not be victimized for raising complaints and have the right to be accompanied or represented.</i>	
3.12.2 The complaints procedure includes details of who to contact in the Flag Administration if the complaint is not resolved. <i>The complaints procedure must allow for complaints directly to the Master and to the Flag Administration if the complaint is not resolved.</i>	
3.12.3 Where complaints have been recorded have they been resolved*	

* NA Where the ship owner is the sole seafarer on-board or where there are no complaints received

3.13 Payment of wages	Yes / NA*
3.13.1 Payment of wages is in accordance with the SEA. <i>Payment of wages defines the principles applying to the payment and calculation of basic pay and wages which are partially or fully consolidated.</i>	
3.13.2 Payment of wages is at least monthly. <i>All seafarers shall receive a monthly account of their wages.</i>	
3.13.3 Where possible, seafarers confirm that their wages are being paid in accordance with the SEA	

* NA where the ship owner is the sole seafarer on-board.

4. Declarations

Shipowner's declaration

I declare that I will continue to comply with the requirements of the SCV Code Chapter-IX and Annex 14, 15 B and 16 for the validity of this inspection report.

Ship owner name:

Name of signatory of the ship owner: Signed:

Date:

Inspector's declaration

I declare that I have reviewed the above measures, and, following inspection of the ship, and I have determined that they meet the purposes set out in the SCV Code Chapter-IX and Annex 14, 15 B and 16

Inspector name:

Signed:



Of [insert name of Certifying Authority] authorized by the [name of the Flag Administration]
Date of Inspection:..... This Inspection Report is valid
until.....
(maximum of 3 years from date of inspection date)

This report is to be retained onboard for a period of 3 years and must be made available for consultation by [name of the Flag Administration] and Port State Control officers at all times.

Annex 16

Model of on-board complaint-handling procedures

1 Details of the vessel and complaint

Name of ship:

Official No/Call Sign.....Date:

Name of the seafarer lodging complaint:

Name of the person against who the complaint made:

Nature of complaint:

2 The Master or an officer authorized by the Master on board the ship are to provide seafarers with confidential and impartial advice on a complaint.

3 All attempts to be made to mitigate the complaint at the lowest level where possible.

4 Where mutual agreement to resolve dispute is not achieved the seafarer may take the matter to the next level

5 Seafarers shall have the right to be accompanied or represented during the complaints procedure and shall not be victimized. No person shall victimize any seafarer for filing a complaint and victimization shall be an offence.

6 Notwithstanding 5 above, seafarers shall have the right to complain directly to the Master and, where they consider it necessary, to the ship owner or to the Flag Administration or to appropriate external authorities.

7 Seafarers shall have fourteen (14) days from the date of the alleged occurrence of the complaint to bring the matter to the seafarer's superior officer; the head of the department; the master, each of whom has a further seven (7) days to bring about a solution to the grievance (complaint).

8 If the Master is unable to resolve the matter, the seafarer shall have ten (10) days to bring it through the Master to the ship owner, or where appropriate, directly to the ship owner. However, if the complaint may be to the prejudice of the master, the seafarer may complain directly to the ship owner.

9 The ship owner and the seafarer concerned shall have a period of twenty (20) days to bring the matter to a conciliation.

10 If after twenty (20) days, the matter has not been conciliated, either party shall have a further twenty (20) days to bring the matter for mediation to the flag Administration.